



BG700F12D14S4

$V_{CES} = 1200V$ $I_C = 700A$

General Description

BYD IGBT Power Module BG700F12D14S4 provides low switching loss as well as high short circuit capability, which introduce the advanced FS IGBT chip and ultra fast & soft recovery anti-parallel FRD to improved connection, it is able to take on a perfect performance in various applications up to 16KHz.

比亚迪IGBT功率模块BG700F12D14S4提供低损和高短路能力,内含先进的平面栅场终止技术IGBT和超快速软恢复二极管芯片,在不超过16KHZ频率的应用中表现出优良的性能。

Applications

- AC motor control
交流马达控制
- Inverters
逆变器
- Servo
伺服电机
- Maximum applied voltage platform: 750V
最高支持750电压平台

Features

- Full bridge module
全桥模块
- High short circuit capability
高短路能力
- 1200V planar&field stop technology
1200V 平面栅场终止技术
- Ultra low conduction and switching loss
低导通和开关损耗
- Including ultra fast & soft recovery anti-parallel FRD
反并联超快速软恢复二极管

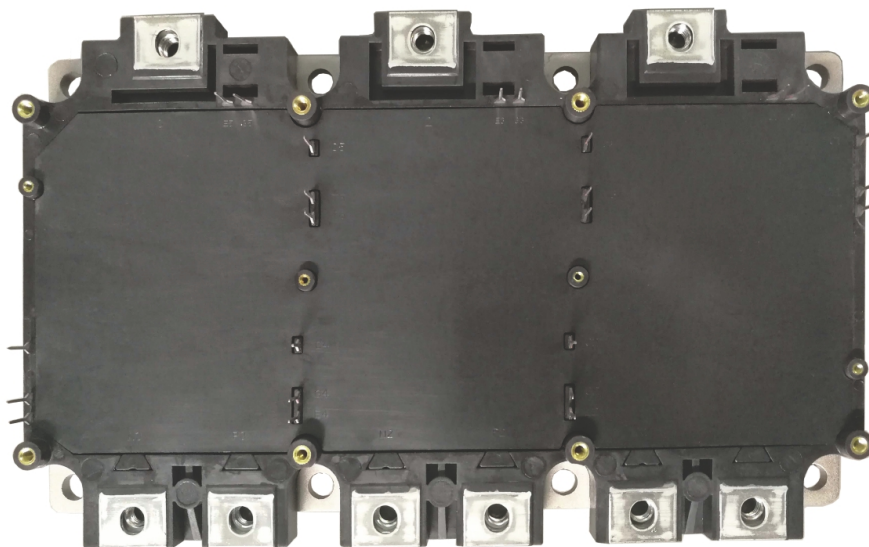



Characteristic Values

Parameter	Symbol	Conditions	Temperature	Value	Unit		
Absolute Maximum Ratings/ 最大额定值							
Collector-emitter voltage 集电极-发射极电压	V_{CES}	$V_{GE}=0V$	$T_{vj}=25^{\circ}C$	1200	V		
Continuous collector current 连续集电极直流电流	I_C	—	$T_F=25^{\circ}C$	700	A		
	I_{cnom}	$V_{CE}=600V$	$T_{vj}=150^{\circ}C$ $T_F=65^{\circ}C$	430			
Peak collector current 集电极峰值电流	I_{CRM}	—	—	1800	A		
Gate-emitter voltage 栅极-发射极电压	V_{GES}	—	—	+/-20	V		
IGBT short circuit SOA IGBT 短路安全工作区	t_{psc}	$V_{CC}=800V,$ $V_{CEM}\leq 1200V,$ $V_{GE}\leq 15V$	$T_{vj}\leq 150^{\circ}C$	10	us		
Junction temperature 结温	T_{vj}	—	—	-40~175	$^{\circ}C$		
Storage temperature range 存储温度	T_{stg}	—	—	-40~150	$^{\circ}C$		
Diode DC forward current 二极管直流正向电流	I_F	—	$T_C=25^{\circ}C$	700	A		
Isolation voltage 绝缘电压	V_{isol}	AC, $t=1min,$ $f=50Hz$	—	3000	V		
Total power dissipation 耗散功率	P_{tot}	per switch (IGBT)	$T_F= 25^{\circ}C$	1613	W		
IGBT Characteristics IGBT 特性							
IGBT				Min.	Typ.	Max.	Unit
Collector-emitter breakdown voltage 集电极-发射极击穿电压	$V_{(BR)CES}$	$V_{GE}=0V,$ $I_C=1mA$	$T_{vj}=25^{\circ}C$	1200	—	—	V
Gate-emitter threshold voltage 栅极-发射极阈值电压	$V_{GE(th)}$	$I_C=24mA,$ $V_{CE}=V_{GE}$	$T_{vj}=25^{\circ}C$	5.0	—	7.0	V
Collector-emitter cut-off current 集电极-发射极截止电流	I_{CES}	$V_{CE}=1200V,$ $V_{GE}=0V$	$T_{vj}=25^{\circ}C$	—	—	1.2	mA
Collector-emitter saturation voltage 集电极-发射极饱和电压	$V_{CE(sat)}$	$I_C=600A,$ $V_{GE}=15V$	$T_{vj}=25^{\circ}C$	1.8	2.05	2.7	V
			$T_{vj}=125^{\circ}C$	—	2.15	—	V
			$T_{vj}=150^{\circ}C$	—	2.20	—	V
Integrated gate resistor 内部栅极电阻	R_{Gint}	—	$T_{vj}=25^{\circ}C$	—	0.65	—	Ω
Parameter	Symbol	Conditions	Temperature	Min.	Typ.	Max.	Unit



IGBT Characteristics/ IGBT 特性							
Gate-emitter leakage current 栅极-发射极漏电流	I_{GES}	$V_{GE}=\pm 20V,$ $V_{CE}=0V$	$T_{vj}=25^{\circ}C$	-600	—	600	nA
Input capacitance 输入电容	C_{ies}	$V_{CE}=25V,$ $V_{GE}=0V,$ $f=1MHz$	—	—	23.78	—	nF
Reverse transfer capacitance 反向传输电容	C_{res}		—	—	1.05	—	nF
Turn-on delay time 开通延迟时间	$t_{d(on)}$	$V_{CC}=600V$ $I_c=600A,$ $R_{Gon}=2.5\Omega,$ $R_{Goff}=5\Omega$ $V_{GEon}=+15V$ $V_{GEoff}=-8V$ $L_s=30nH$	$T_{vj}=25^{\circ}C$	—	210	—	ns
			$T_{vj}=125^{\circ}C$	—	218	—	ns
			$T_{vj}=150^{\circ}C$	—	215	—	ns
Rise time 上升时间	t_r		$T_{vj}=25^{\circ}C$	—	260	—	ns
			$T_{vj}=125^{\circ}C$	—	215	—	ns
			$T_{vj}=150^{\circ}C$	—	233	—	ns
Turn-off delay time 关断延迟时间	$t_{d(off)}$		$T_{vj}=25^{\circ}C$	—	653	—	ns
			$T_{vj}=125^{\circ}C$	—	740	—	ns
			$T_{vj}=150^{\circ}C$	—	760	—	ns
Fall time 下降时间	t_f		$T_{vj}=25^{\circ}C$	—	90	—	ns
			$T_{vj}=125^{\circ}C$	—	100	—	ns
			$T_{vj}=150^{\circ}C$	—	105	—	ns
Energy dissipation during turn-on time 开通损耗	E_{on}	$T_{vj}=25^{\circ}C$	—	120	—	mJ	
		$T_{vj}=125^{\circ}C$	—	130	—	mJ	
		$T_{vj}=150^{\circ}C$	—	134	—	mJ	
Energy dissipation during turn-off time 关断损耗	E_{off}	$T_{vj}=25^{\circ}C$	—	57	—	mJ	
		$T_{vj}=125^{\circ}C$	—	75	—	mJ	
		$T_{vj}=150^{\circ}C$	—	85	—	mJ	
Diode Characteristics/ 二极管特征值							
Forward voltage 正向电压	V_F	$I_F=600A$ $V_{GE}=0V$	$T_{vj}=25$	—	1.8	—	V
			$T_{vj}=125^{\circ}C$	—	1.7	—	V
			$T_{vj}=150^{\circ}C$	—	1.7	—	V
Peak reverse recovery current 反向恢复峰值电流	I_{RR}	$I_F=600A,$ $V_R=600V$	$T_{vj}=25^{\circ}C$	—	90	—	A
			$T_{vj}=125^{\circ}C$	—	145	—	A
			$T_{vj}=150^{\circ}C$	—	160	—	A
Recovered charge 恢复电荷	Q_r		$T_{vj}=25^{\circ}C$	—	33	—	uC
			$T_{vj}=125^{\circ}C$	—	67	—	uC
			$T_{vj}=150^{\circ}C$	—	74	—	uC
Reverse recovery energy 反向恢复能量	E_{rec}		$T_{vj}=25^{\circ}C$	—	10	—	mJ
			$T_{vj}=125^{\circ}C$	—	25	—	mJ
			$T_{vj}=150^{\circ}C$	—	26	—	mJ



Parameter	Symbol	Conditions	Min.	Typ.	Max.	Unit	
Thermal-Mechanical Specifications							
Thermal resistance junction to coolant 结到冷却液热阻	$R_{th(j-f)}$	IGBT	—	0.093	—	K/W	
	$R_{th(j-f)}$	FRD	—	0.12	—	K/W	
Module Characteristics/ 模块特性							
Dimensions 尺寸	L x W x H	Typical , see outline drawing	225×137×34.7			mm	
Clearance distance in air 空气间隙	da	according to IEC 60664-1 and EN 50124-1	Term. to base:	—	16.0	—	mm
			Term. to term:	—	11.5	—	
Surface creepage distance 爬电距离	ds	according to IEC 60664-1 and EN 50124-1	Term. to base:	22	16.0	—	mm
			Term. to term:	—	12.5	—	
Stray inductance module 模块杂散电感	LsCE	—	—	23	—	nH	
Mass 重量	m	—	—	2082	—	g	
Pressure drop in cooling circuit 在冷却液中的压差	ΔP	$\Delta v / \Delta t = 12L/min$, $T = 25^{\circ}C$ cooling fluid=50% water/50% ethylenglycol	—	10	—	KPa	
Maximum pressure in cooling circuit 冷却循环中的最大压力	P	—	—	—	250	KPa	
Mounting torque 安装扭矩	M	Screw M6-mounting according to valid application note	3.0	—	4.5	Nm	
Terminal connection torque 端子连接扭矩	M	Screw M6-mounting according to valid application note	3.0	—	4.5	Nm	
NTC-Thermistor Characteristic Values/ 热敏电阻特性							
Rated resistance 额定阻值	R_{25}	$T_C = 25^{\circ}C$	—	5.0	—	K Ω	
Deviation of R100 R100 偏差	$\Delta R/R$	$T_C = 100^{\circ}C$, $R_{100} = 493\Omega$	-5	—	5	%	
Power dissipation 耗散功率	P_{25}	$T_C = 25^{\circ}C$	—	—	20.0	mW	
B-value B-值	$B_{25/50}$	$R_2 = R_{25} \exp[B_{25/50}(1/T_2 - 1/(298.15K))]$	—	3375	—	K	
B-value B-值	$B_{25/80}$	$R_2 = R_{25} \exp[B_{25/80}(1/T_2 - 1/(298.15K))]$	—	3411	—	K	
B-value B-值	$B_{25/100}$	$R_2 = R_{25} \exp[B_{25/100}(1/T_2 - 1/(298.15K))]$	—	3433	—	K	

Thermal and mechanical properties according to IEC 60747 – 15, Specification according to the valid application note 热和机械特性参考 IEC 60747 – 15I-

Characteristics Diagrams/特性曲线

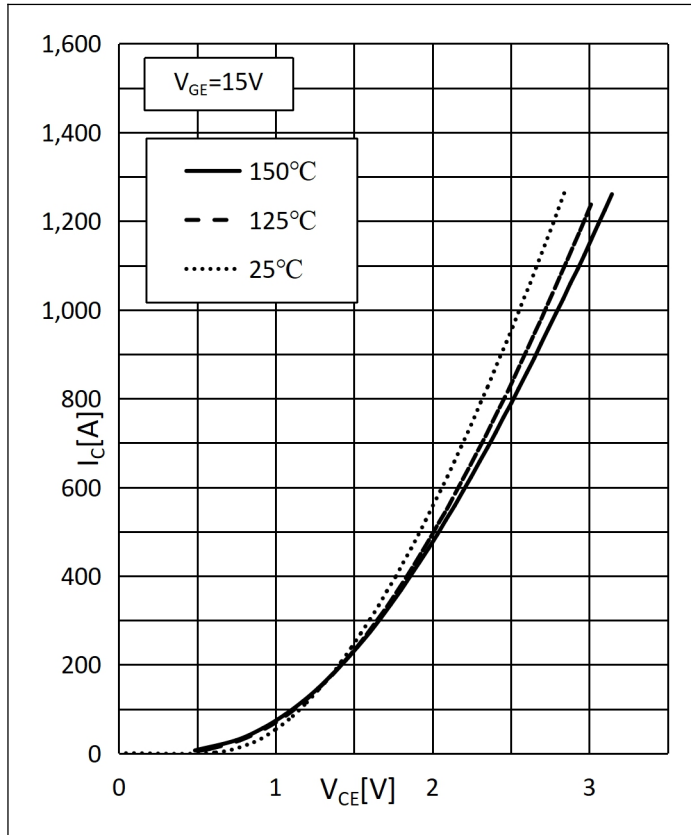

Fig.1: On-state Characteristics
图 1: 通态特性

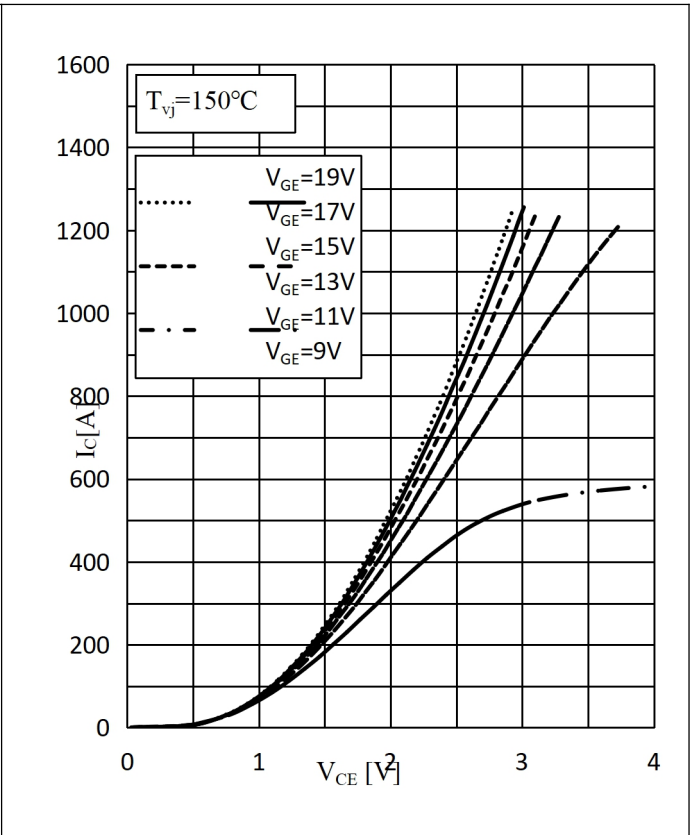

Fig.2: Output characteristics
图 2: 输出特性

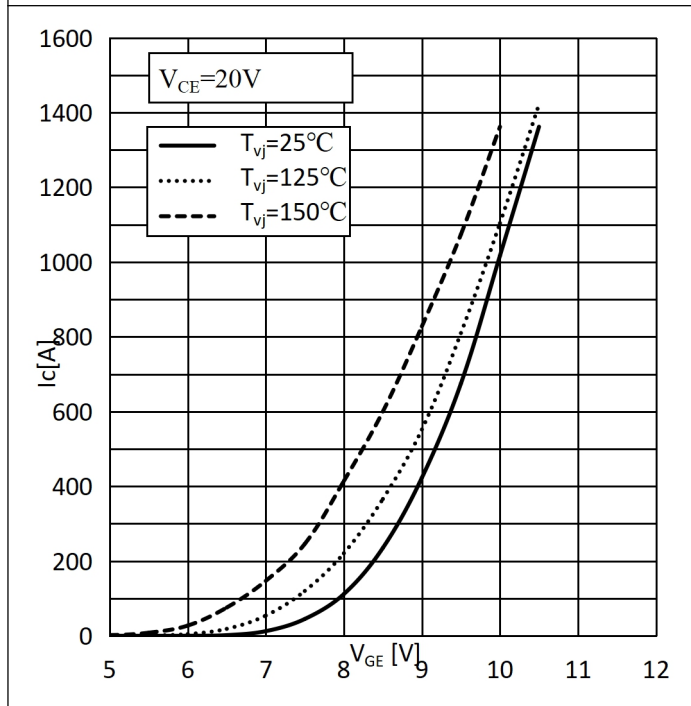

Fig.3: Transfer Characteristics
图 3: 传输特性

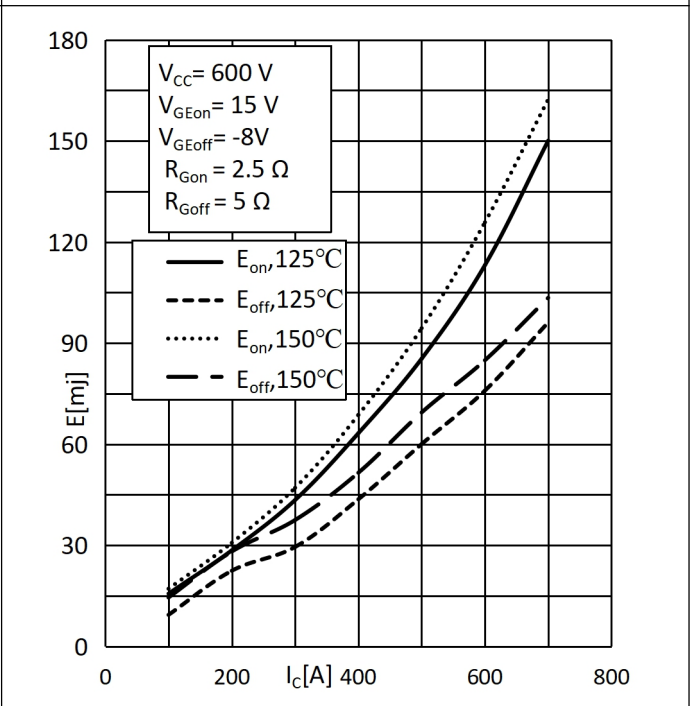

Fig.4: Switching Loss vs. Collector Current
图 4: 开关损耗与集电极电流关系

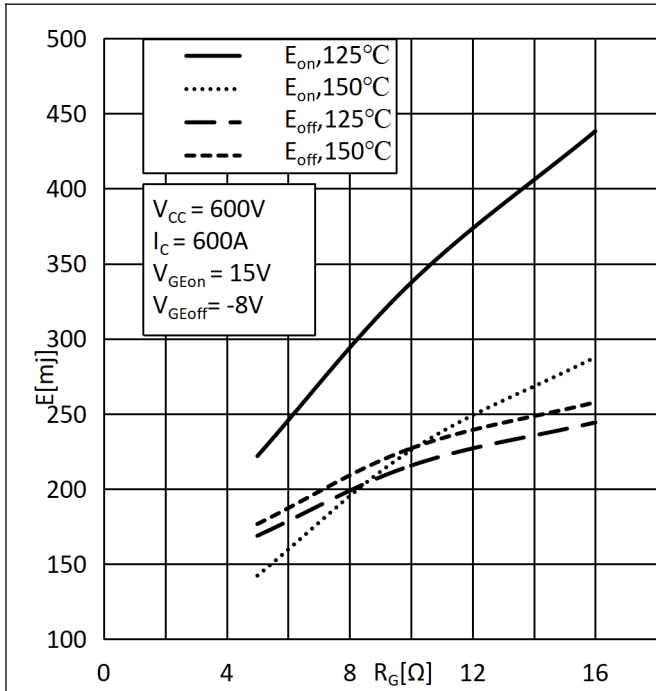

Fig.5: Switching Loss vs. Gate Resistor

图 5: 开关损耗与门极电阻关系

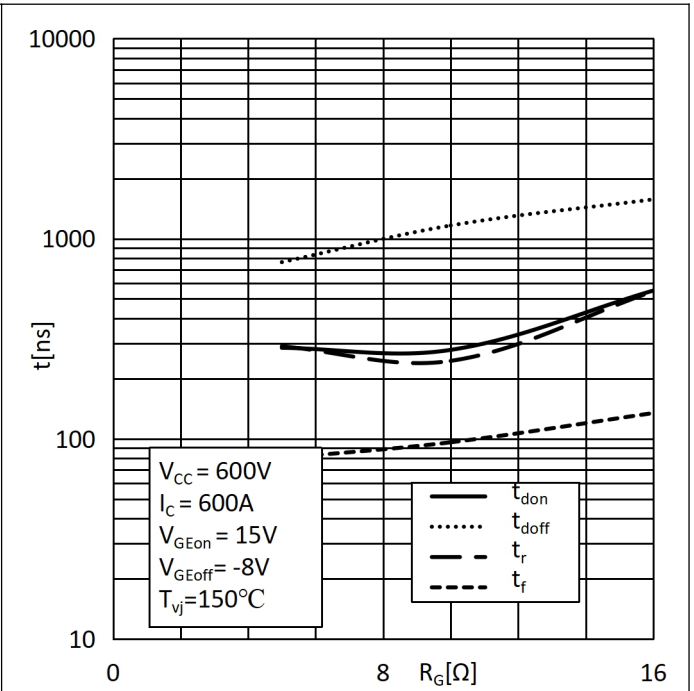

Fig.6: Switching Times vs. Gate Resistor

图 6: 开关时间与门极电阻关系

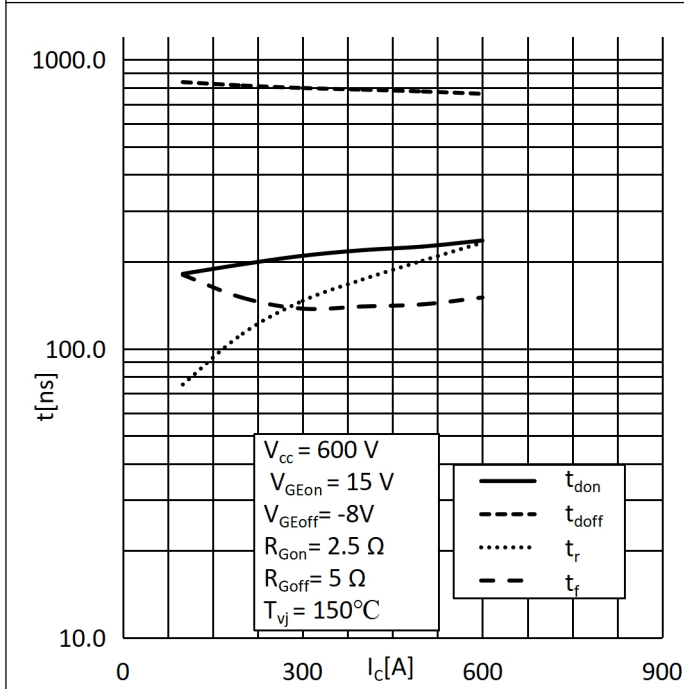

Fig.7: Switching Times vs. I_c

图 7: 开关时间与集电极电流关系

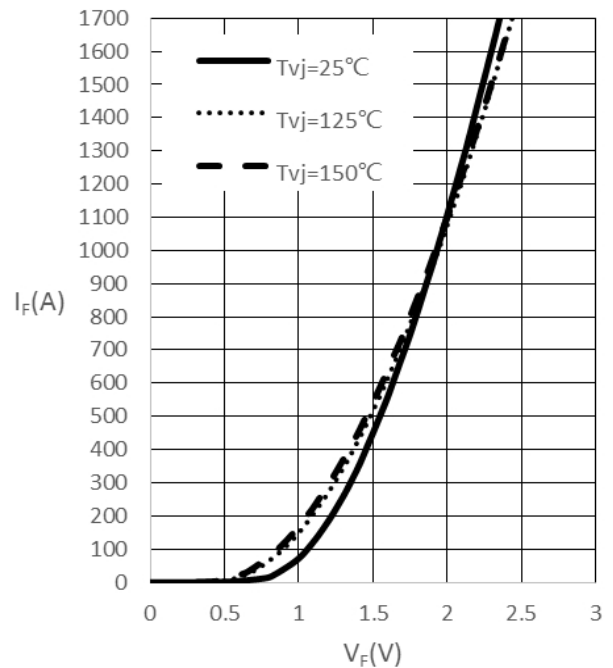

Fig.8: Forward characteristic

图 8: 正向特性

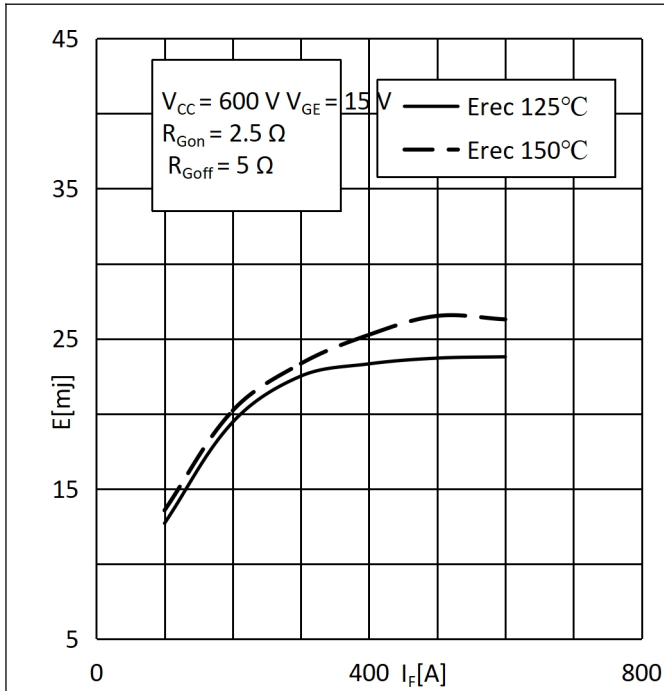

Fig.9: Reverse recovery Energy vs I_F .
图 9: 反向恢复损耗与正向电流的关系

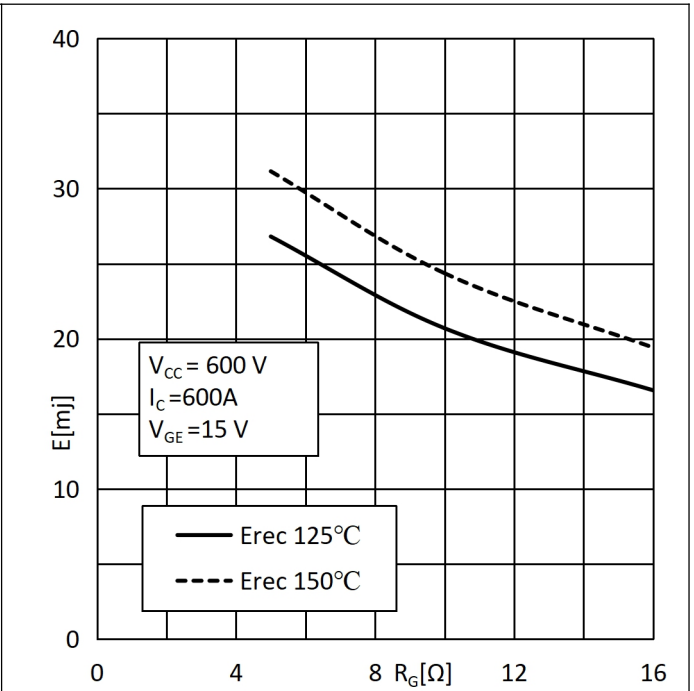

Fig.10: Reverse recovery Energy vs. Gate Resistor
图 10: 反向恢复损耗与门极电阻关系

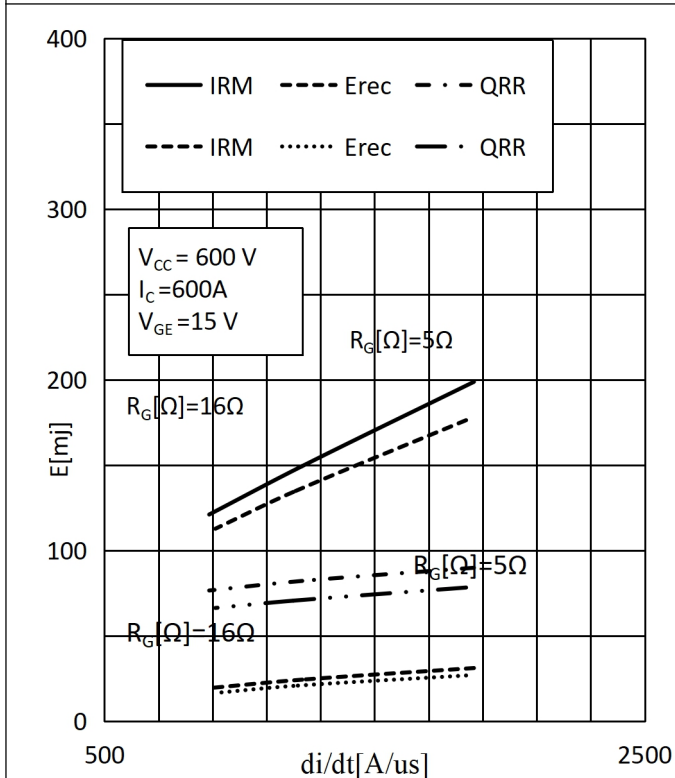

Fig.11: Reverse Recovery Characteristics vs. di/dt
图 11: 反向恢复与正向电流关系

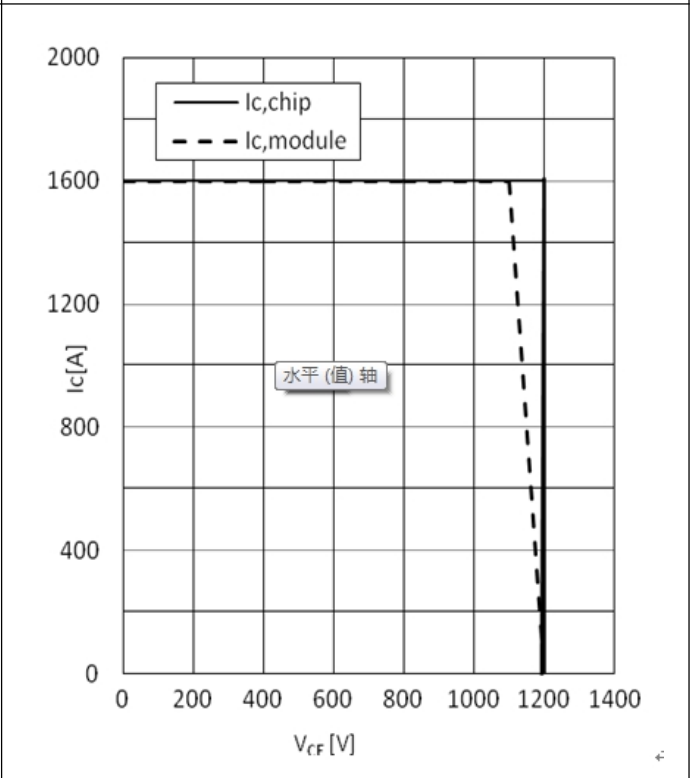

Fig.12: Reverse Bias Safe Operating Area
图 12: 反偏安全工作区

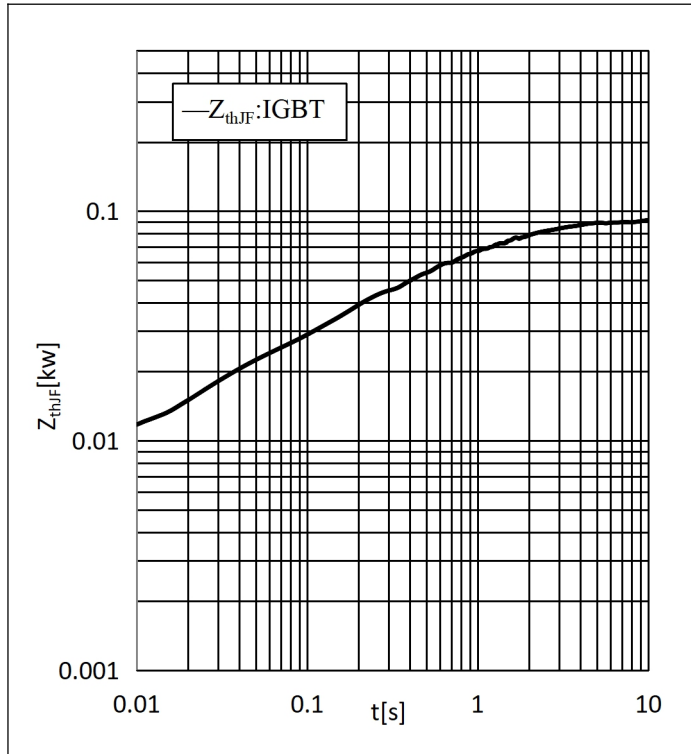

Fig. 13: Typ. transient thermal impedance(IGBT) Z_{thJF} IGBT(K/W)

图 13: 典型的瞬态热阻抗(IGBT) Z_{thJF} IGBT(K/W)

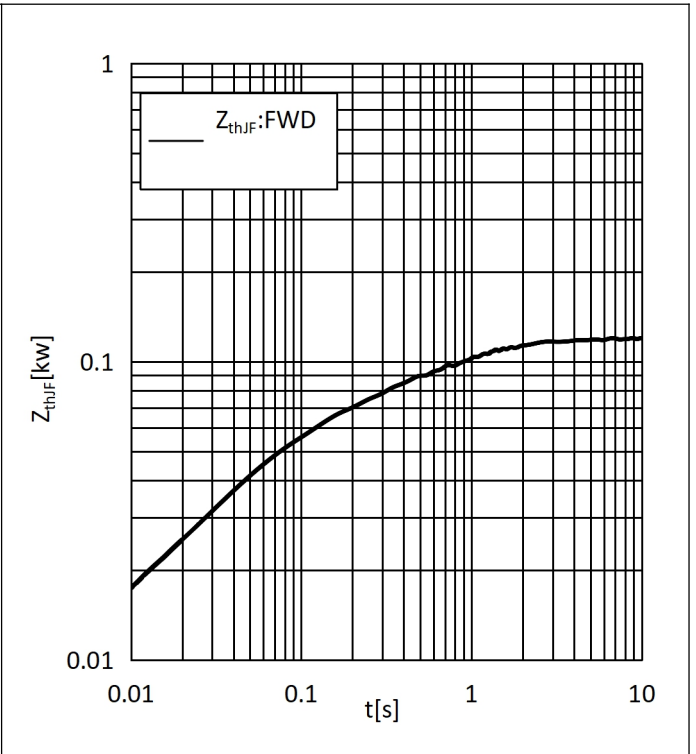

Fig. 14: Typ. transient thermal impedance(FRD) Z_{thJF} FRD(K/W)

图 14: 典型的瞬态热阻抗(FRD) Z_{thJF} FRD(K/W)

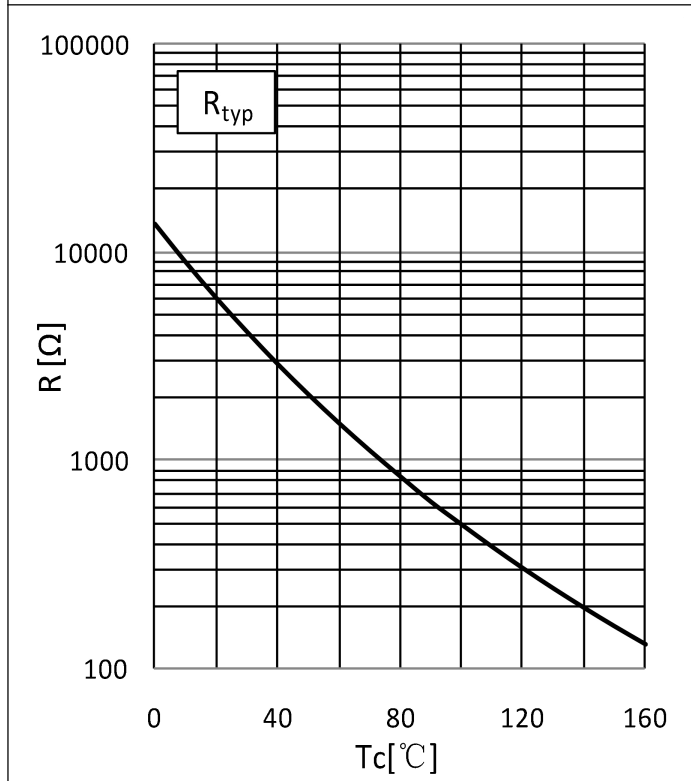
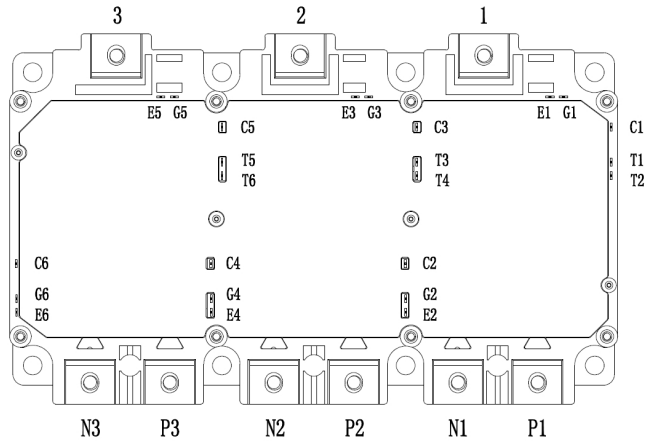
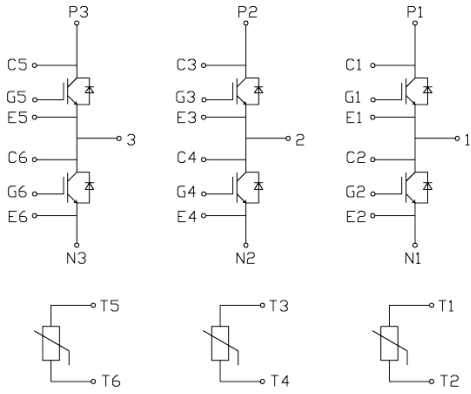

Fig. 15: Typ. NTC-Temperature Characteristics

图 15: 典型的 NTC 电阻-温度特性



Circuit Diagram/接线图



Package outlines/封装尺寸

带*号尺寸为 ± 0.3

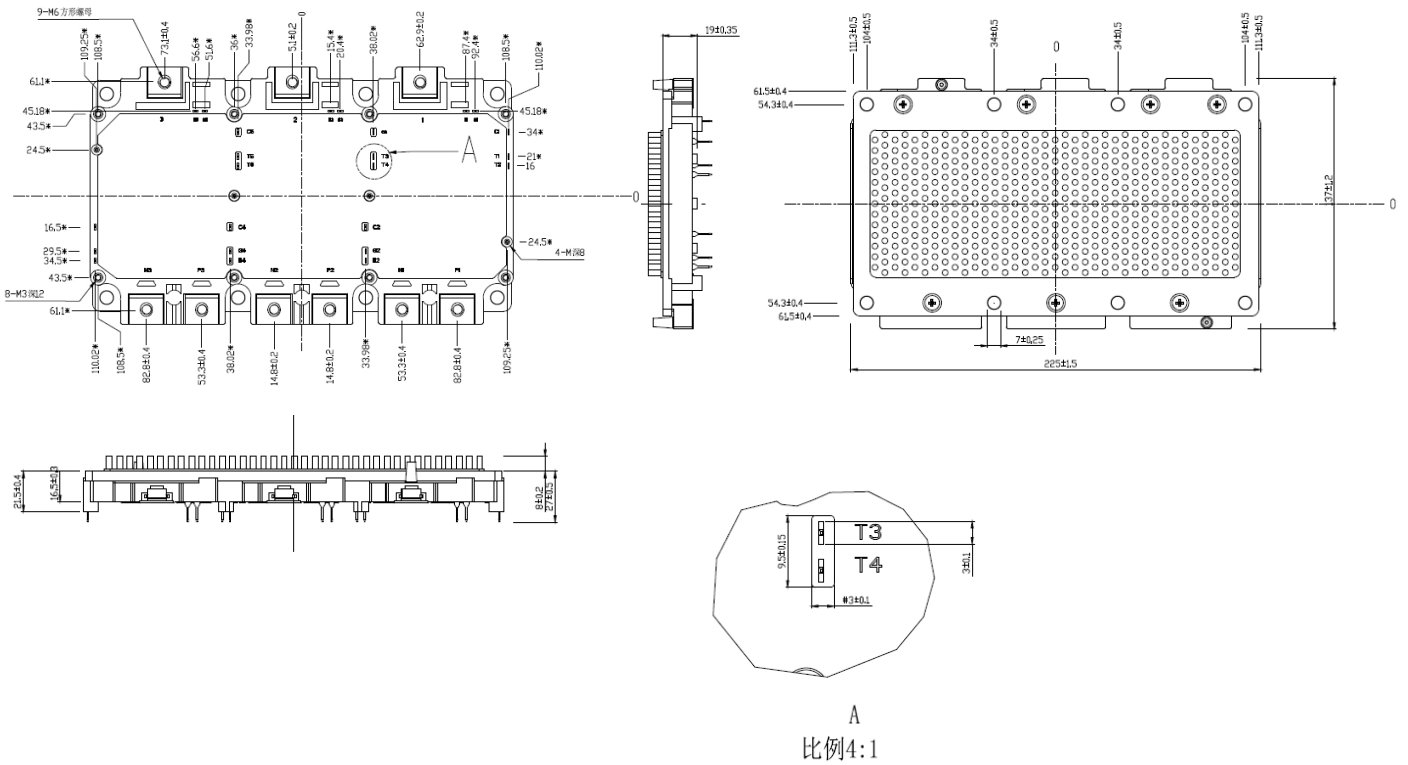



Attached (recommended torque and screw):

Terminal Torque(M6): pre-tightening torque 0.5 N.m and final torque 3.0-4.5 N·m

端子扭矩(M6)预紧扭矩0.5 N.m, 最终扭矩3.0-4.5 N·m

Mounting Torque(M3):0.5-1.0 N·m

安装扭矩(M3): 0.5-1.0 N·m

For the 1.0mm thickness shielding plate mounting, we suggest you use the M2x5 screws

对于1.0mm厚度的屏蔽板安装, 建议使用M2X5的螺钉。

Attention

1. When installing the module, please wear an electrostatic bracelet to prevent the gate breakdown and the imbalance power may damage the internal chip, even to damage the module.

当您安装模块时, 请佩戴静电手环防止栅极被击穿, 静电可能会破坏芯片, 甚至损坏模块。

2. This is an electrostatic sensitive device, please observe the international standard IEC 60747-1, chap. IX.

这是静电敏感器件, 请遵循国际标准 IEC 60747-1, chap. IX。

Restrictions on Product Use

产品应用的限制

- The information contained herein is subject to change without notice.

此处包含的信息如有变更, 不另通知。

- **BYD Semiconductor Company Limited** exerts the greatest possible effort to ensure high quality and reliability. Nevertheless, semiconductor devices in general can malfunction or fail due to their inherent electrical sensitivity and vulnerability to physical stress. It is the responsibility of the buyer, when utilizing products, to comply with the standards of safety in making a safe design for the entire system, including redundancy, fire-prevention measures, and malfunction prevention, to prevent any accidents, fires, or community damage that may ensue. In developing your designs, please ensure that products are used within specified operating ranges as set forth in the most recent products specifications.

比亚迪半导体股份有限公司致力于产品的高性能和高可靠性。然而, 因为半导体器件固有的电敏感和较弱的抗物理压力能力, 模块容易因此导致失效。当用户购买的产品时, 用户有责任按照安全标准来为整个系统做出安全的设计, 包括冗余度、防火、失效预防、来预防任何可能发生的事故、火灾或者可能引起的社区危害。请改善您的设计, 确保的产品在额定范围内使用并参考最新的产品规格书。



- The products listed in this document are intended for usage in general electronics applications (personal equipment, measuring equipment, industrial robotics, domestic appliances, etc. These products are neither intended nor warranted for usage in equipment that requires extraordinarily high quality and/or reliability or a malfunction or failure of which may cause loss of human life or bodily injury (“Unintended Usage”). Unintended Usage include atomic energy control instruments, airplane or spaceship instruments, transportation instruments, traffic signal instruments, combustion control instruments, medical instruments, all types of safety devices, etc.. Unintended Usage of BME products listed in this document shall be made at the customer’s own risk.

目录中列出的产品是用于通用电子装置(个人装置、测量装置、工业机器人、家用电器等等) 这些的产品既不是用于超高质量要求,也不是用于失效后会危害人身安全的场合。比如原子能控制装置、飞机或航空器装置、运输装置、交通信号装置、燃烧控制装置、医疗装置、所有类型的安全设备等等,用在这些不合适的场合会导致用户自己的风险。