

IGBT Power Module

IGBT 功率模块

□ General Description

This IGBT module, which adopts general packaging, can meet the auto grade standards. Compared with other manufacturers, the BYD module adopts DBC with other elements, which has higher strength. DBC can be made thinner, less thermal resistance and better heat dissipation in the case of constant intensity requirements. In order to adapt to the complex automotive application environment at the same time, the module framework adopted a more excellent performance of PPS material, its temperature is higher, the intensity is harder, not deformation, corrosion resistance stronger, etc, to ensure product quality and reliability.



□ 概述

这款 IGBT 模块采用了标准封装,可以满足汽车级标准。与竞品相比, BYD 模块采用了具有更高强度材料的 DBC, 更薄的 DBC 厚度, 更低的热阻, 以及更低的损耗。同时为了适应复杂的车用环境, 模块外框材料采用了特性更好的 PPS 材料, 它有更好的耐热性能, 不易变形, 不易腐蚀等优点, 来确保模块的质量及可靠性。

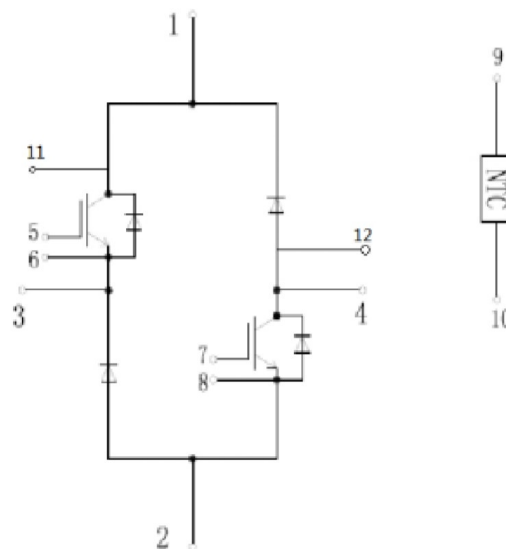

□ Key Features

- H-bridge
- Low inductance
- Standard package
- High short circuit capability
- Ultra low conduction and switching loss
- Including ultra fast&soft recovery anti-parallel FWD

□ 关键特性

- H 桥结构
- 更低的电感
- 标准封装
- 更高的短路耐量
- 超低的通态及开关损耗
- 包含快软恢复并联续流二极管

□ Applications

- Servo Applications
- Motor Drives
- UPS Systems

□ 应用

- 伺服应用
- 电机驱动
- UPS 系统

IGBT/ IGBT
Maximum Rated Values of IGBT / IGBT 最大额定值

Parameter	Symbol	Conditions	Values	Units
Collector-emitter voltage 集电极-发射极电压	V_{CES}	$T_{vj}=25^{\circ}\text{C}, V_{GE}=0\text{V}$	1200	V
Continuous collector current 连续集电极直流电流	I_C	$T_c=25^{\circ}\text{C}, T_{vj}=175^{\circ}\text{C}$	1200	A
	$I_{C\text{nom}}$	$T_c=80^{\circ}\text{C}, T_{vj}=175^{\circ}\text{C}$	600	A
Gate-emitter voltage 栅极-发射极电压	V_{GES}	$T_{vj}=25^{\circ}\text{C}$	± 20	V
Peak collector current 集电极峰值电流	I_{CRM}	$t_p=1\text{ms}, T_{vj}=25^{\circ}\text{C}$	1200	A
SC data 短路数据	I_{SC}	$V_{GE} \leq 15\text{V}, V_{CC}=800\text{V}$ $V_{CE\text{max}}=V_{CES} - L_{sCE} * di/dt$ $t_p \leq 10\mu\text{s}, T_{vj}=150^{\circ}\text{C}$	3600	A
Total power dissipation 总耗散功率	P_{tot}	$T_c=25^{\circ}\text{C}, T_{vj}=175^{\circ}\text{C}$	4285	W

Characteristics Values of Chopper IGBT/斩波 IGBT 特征值

Parameter	Symbol	Conditions	Values			Units
			Min.	Typ.	Max.	
Collector-Emitter Saturation Voltage 集电极-发射极饱和电压	$V_{CE\text{sat}}$	$I_C=600\text{A}, V_{GE}=15\text{V}, T_{vj}=25^{\circ}\text{C}$	-	2.2	-	V
		$I_C=600\text{A}, V_{GE}=15\text{V}, T_{vj}=125^{\circ}\text{C}$	-	2.4	-	V
		$I_C=600\text{A}, V_{GE}=15\text{V}, T_{vj}=150^{\circ}\text{C}$	-	2.5	-	V
Gate-emitter threshold voltage 栅极-发射极阈值电压	$V_{GE\text{th}}$	$V_{CE}=V_{GE}, I_C=24\text{mA}, T_{vj}=25^{\circ}\text{C}$	5.0	6.0	7.0	V
Gate charge 栅极电荷	Q_G	$V_{GE}=-15\text{V}\dots+15\text{V}$	-	1	-	μC
Internal gate resistor 内部栅极电阻	R_{gint}	$T_{vj}=25^{\circ}\text{C}$	-	1.3	-	Ω
Input capacitance 输入电容	C_{ies}	$T_{vj}=25^{\circ}\text{C}, f=1\text{MHz}, V_{GE}=0\text{V}, V_{CE}=25\text{V}$	-	15.9	-	nF
Reverse transfer capacitance 反向传输电容	C_{res}		-	0.7	-	nF
Collector-emitter cut-off current 集-发射极截止电流	I_{CES}	$V_{CE}=1200\text{V}, V_{GE}=0\text{V}, T_{vj}=25^{\circ}\text{C}$	-	-	0.6	mA

Parameter	Symbol	Conditions	Values			Units	
			Min.	Typ.	Max.		
G-E leakage current 栅极-发射极漏电流	I_{GES}	$V_{CE}=0V, V_{GE}=20V, T_{vj}=25^{\circ}C$	-	-	600	nA	
Turn-on delay time 开通延迟时间	$t_{d\ on}$	$I_C=600A,$ $V_{CE}=600V,$ $V_{GE}=-8V\dots+15V$	$T_{vj}=25^{\circ}C$	-	140	-	ns
			$T_{vj}=125^{\circ}C$		150		ns
			$T_{vj}=150^{\circ}C$	-	155	-	ns
Rise time 上升时间	t_r		$T_{vj}=25^{\circ}C$	-	240	-	ns
			$T_{vj}=125^{\circ}C$		245		ns
			$T_{vj}=150^{\circ}C$	-	245	-	ns
Turn-off delay time, 关断延迟时间	$t_{d\ off}$		$T_{vj}=25^{\circ}C$	-	340	-	ns
			$T_{vj}=125^{\circ}C$		400		ns
			$T_{vj}=150^{\circ}C$	-	415	-	ns
Fall time 下降时间	t_f	$R_{Gon}=1\Omega,$	-	56	-	ns	
		$R_{Goff}=1\Omega,$		220		ns	
		$L_s=30nH$	-	265	-	ns	
Turn-on energy loss 开通损耗	E_{on}	$T_{vj}=25^{\circ}C$	-	110	-	mJ	
		$T_{vj}=125^{\circ}C$		125		mJ	
		$T_{vj}=150^{\circ}C$	-	130	-	mJ	
Turn-off energy loss 关断损耗	E_{off}	$T_{vj}=25^{\circ}C$	-	40	-	mJ	
		$T_{vj}=125^{\circ}C$		55		mJ	
		$T_{vj}=150^{\circ}C$	-	65	-	mJ	

□ FRD/二极管

● Maximum Rated Values of Diode / 二极管最大额定值

Parameter	Symbol	Conditions	Values	Units
Repetitive peak reverse voltage 反向重复峰值电压	V_{RRM}	$T_{vj}=25^{\circ}C$	1200	V
Diode DC forward current 二极管直流正向电流	I_F		600	A
Repetitive peak forward current 正向重复峰值电流	I_{FRM}	$t_p=1ms$	1200	A
I^2t -value I^2t -值	I^2t	$V_R=0V, t_p=10ms, T_{vj}=125^{\circ}C$ $V_R=0V, t_p=10ms, T_{vj}=150^{\circ}C$	45000 36000	A^2s

● Characteristics Values of Diode/ 二极管特征值

Parameter	Symbol	Conditions	Values			Units	
			Min.	Typ.	Max.		
Forward voltage 正向电压	V_F	$I_F=600A,$ $V_{GE}=0V$	$T_{vj}=25^{\circ}C$	-	2.0	-	V
			$T_{vj}=125^{\circ}C$	-	2.1	-	V
			$T_{vj}=150^{\circ}C$	-	2.1	-	V
Peak reverse recovery current 反向恢复峰值电流	I_{RM}	$I_F=600 A,$ $V_R = 600 V,$ $V_{GE}=-8V...+15V,$ $di/dt=6900A/us$ ($T_{vj}=150^{\circ}C$)	$T_{vj}=25^{\circ}C$	-	75	-	A
			$T_{vj}=125^{\circ}C$	-	135	-	A
			$T_{vj}=150^{\circ}C$	-	155	-	A
Recovered charge 恢复电荷	Q_r	$I_F=600 A,$ $V_R = 600 V,$ $V_{GE}=-8V...+15V,$ $di/dt=6900A/us$ ($T_{vj}=150^{\circ}C$)	$T_{vj}=25^{\circ}C$	-	25	-	μC
			$T_{vj}=125^{\circ}C$	-	58	-	μC
			$T_{vj}=150^{\circ}C$	-	66	-	μC
Reverse recovery energy 反向恢复损耗	E_{rec}	$I_F=600 A,$ $V_R = 600 V,$ $V_{GE}=-8V...+15V,$ $di/dt=6900A/us$ ($T_{vj}=150^{\circ}C$)	$T_{vj}=25^{\circ}C$	-	10	-	mJ
			$T_{vj}=125^{\circ}C$	-	22	-	mJ
			$T_{vj}=150^{\circ}C$	-	25	-	mJ

● Maximum Rated Values of Reverse Diode/ 反向恢复二极管最大额定值

Parameter	Symbol	Conditions	Values	Units
Repetitive peak reverse voltage 反向重复峰值电压	V_{RRM}	$T_{vj}=25^{\circ}C$	1200	V
Diode DC forward current 二极管直流正向电流	I_F	$T_C=25^{\circ}C$	35	A
Repetitive peak forward current 正向重复峰值电流	I_{FRM}	$t_p=1ms, T_{vj}=25^{\circ}C$	70	A
I^2t -value I^2t -值	I^2t	$V_R=0V, t_p=10ms, T_{vj}=125^{\circ}C$	610	A^2s

● Characteristics Values of Reverse Diode/反向恢复二极管特征值

Parameter	Symbol	Conditions	Values			Units	
			Min.	Typ.	Max.		
Forward voltage 正向电压	V_F	$I_F=35A,$ $V_{GE}=0V$	$T_{vj}=25^{\circ}C$	-	1.9	-	V
			$T_{vj}=125^{\circ}C$	-	1.9	-	V
			$T_{vj}=150^{\circ}C$	-	1.9	-	V
Peak reverse recovery current 反向恢复峰值电流	I_{RM}	$I_F=35 A,$ $V_R = 600 V,$ $V_{GE}=-8V...+15V,$ $di/dt=900A/us$	$T_{vj}=25^{\circ}C$	-	48	-	A
			$T_{vj}=125^{\circ}C$	-	49	-	A
			$T_{vj}=150^{\circ}C$	-	42	-	A
Recovered charge 恢复电荷	Q_{rr}	$I_F=35 A,$ $V_R = 600 V,$ $V_{GE}=-8V...+15V,$ $di/dt=900A/us$	$T_{vj}=25^{\circ}C$	-	1.4	-	μC
			$T_{vj}=125^{\circ}C$	-	4.4	-	μC
			$T_{vj}=150^{\circ}C$	-	5.1	-	μC
Reverse recovery energy 反向恢复损耗	E_{rec}	$I_F=35 A,$ $V_R = 600 V,$ $V_{GE}=-8V...+15V,$ $di/dt=900A/us$	$T_{vj}=25^{\circ}C$	-	0.7	-	mJ
			$T_{vj}=125^{\circ}C$	-	1.4	-	mJ
			$T_{vj}=150^{\circ}C$	-	1.9	-	mJ

□ Module/模块

Parameter	Symbol	Conditions	Values			Units
			Min.	Typ.	Max.	
Maximum junction temperature 最大结温	T_{vjmax}	-	-	-	175	$^{\circ}C$
Temperature under switching conditions 开关状态下温度	T_{vjop}	-	-40	-	150	$^{\circ}C$
Storage temperature 储存温度	T_{stg}	-	-40	-	150	$^{\circ}C$
IGBT, thermal resistance, junction to case 结-外壳热阻	$R_{thjc IGBT}$	per IGBT 每个 IGBT	-	0.035	-	K/W
Diode, thermal resistance, junction to case 结-外壳热阻	$R_{thjc Diode}$	per chopper diode 每个斩波二极管	-	0.075	-	K/W
		per reverse diode 每个反向恢复二极管	-	1.0	-	K/W
Stray inductance module 模块杂散电感	L_{sCE}	-	-	23	-	nH
Module lead resistance, terminals - chip 模块引线电阻,端子-芯片	R_{CC+EE}	$T_{vj}=25^{\circ}C$, per switch	-	1.0	-	m Ω

Isolation test voltage 绝缘测试电压	V _{isol}	RMS, f= 50Hz, t = 1min.	3	-	-	KV
Weight 重量	G	-	-	343	-	g
Parameter	Symbol	Conditions	Values			Units
			Min.	Typ.	Max.	
Creepage distance 爬电距离	ds	Terminal to terminal 端子到端子	-	13.0	-	mm
		Terminal to base 端子到基板	-	14.5	-	
Clearance distance in air 空气间隙	da	Terminal to terminal 端子到端子	-	10.0	-	
		Terminal to base 端子到基板	-	12.5	-	
Mounting torque for module mounting 模块的安装扭矩	M ₁	Screw M5 M5 螺栓	3	-	6	N.m
Terminal connection torque 端子的连接扭矩	M ₂	Screw M6 M6 螺栓	3	-	6	N.m
Internal isolation 内部绝缘	-	ceramics 陶瓷	Al ₂ O ₃			-
Material of module baseplate 模块基板材料	-	-	Cu			-
Dimensions 尺寸	L x W x H	-	152.1×62×21			mm

□ NTC-Thermistor/负温度系数热敏电阻

Parameter	Symbol	Conditions	Values			Units
			Min.	Typ.	Max.	
Rated resistance 额定电阻值	R ₂₅	T _C =25°C	-	5.0	-	KΩ
Deviation of R100 R100 偏差	ΔR/R	T _C =100°C, R ₁₀₀ =493Ω	-5	-	5	%
Power dissipation 耗散功率	P ₂₅	T _C =25°C	-	-	20	mW
B-value/B-值	B _{25/50}	$R_2=R_{25}\exp[B_{25/50}(1/T_2-1/(298.15K))]$	-	3375	-	K
B-value/ B-值	B _{25/80}	$R_2=R_{25}\exp[B_{25/80}(1/T_2-1/(298.15K))]$	-	3411	-	K
B-value/ B-值	B _{25/100}	$R_2=R_{25}\exp[B_{25/100}(1/T_2-1/(298.15K))]$	-	3433	-	K

□ Characteristics Diagrams/特性曲线

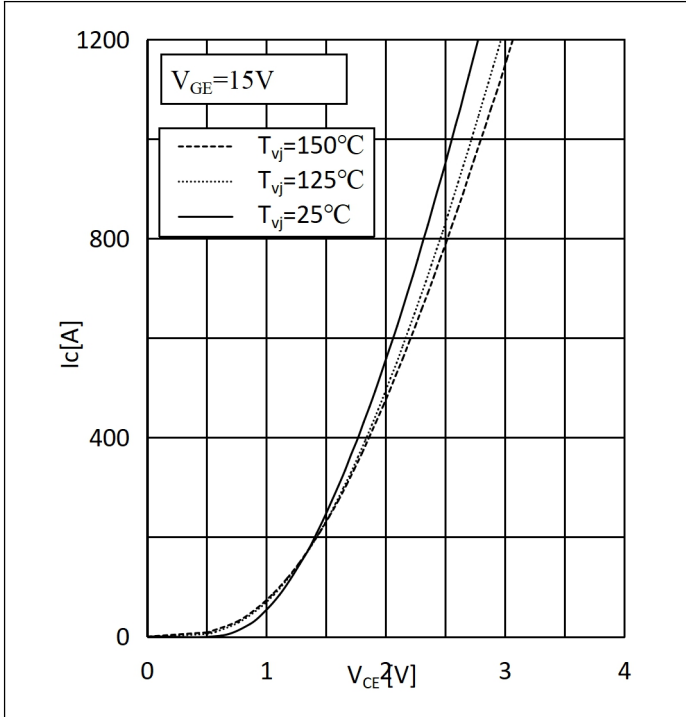

Fig.1: Output Characteristics

图 1: 输出特性

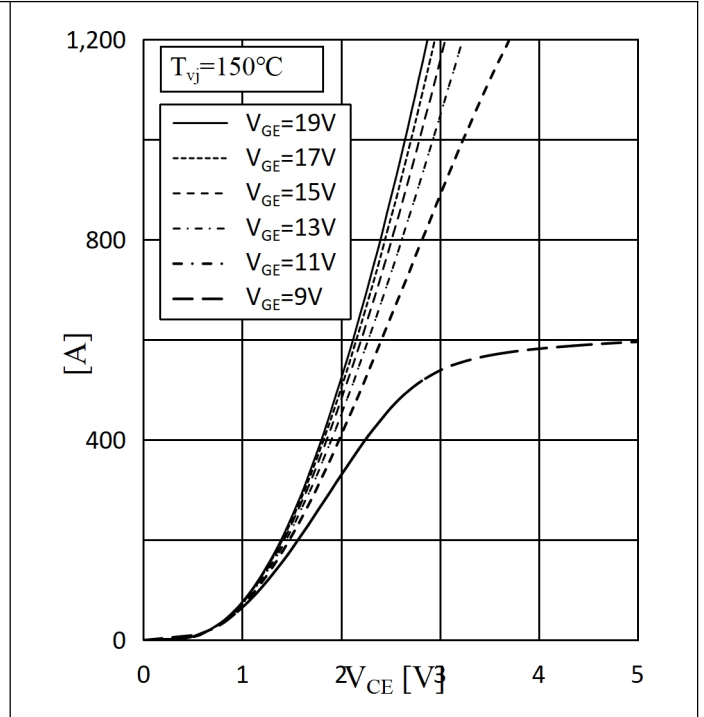

Fig.2: Output characteristics

图 2: 输出特性

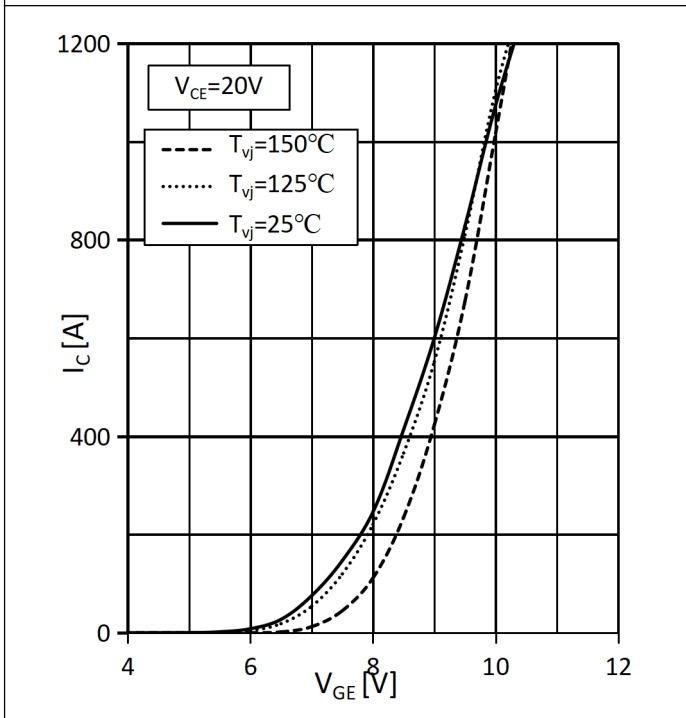

Fig.3: Transfer Characteristics

图 3: 传输特性

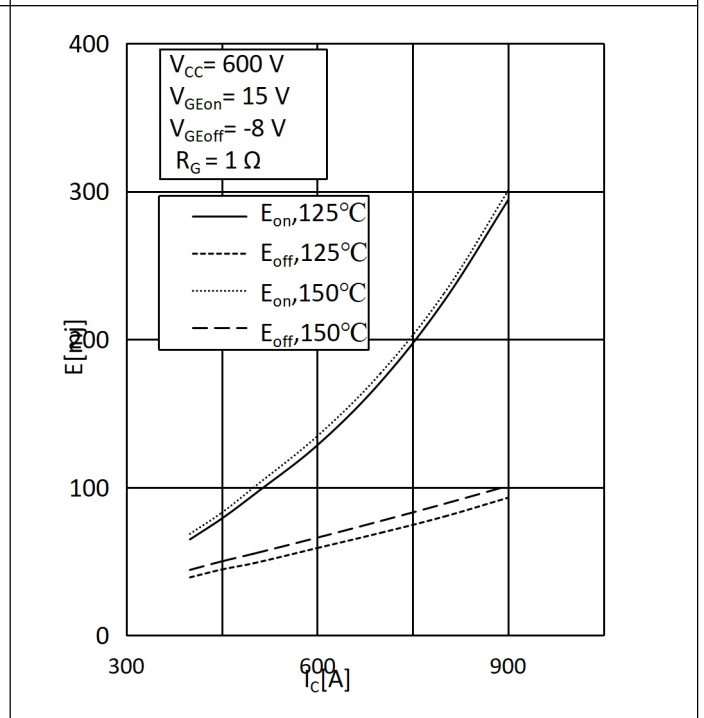

Fig.4: Switching Loss vs. Collector Current

图 4: 开关损耗与集电极电流关系

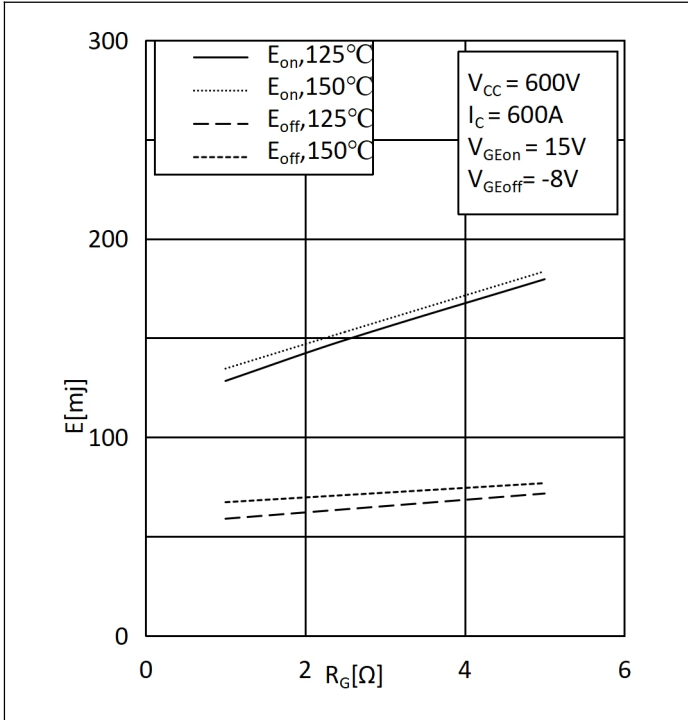

Fig.5: Switching Loss vs. Gate Resistor

图 5: 开关损耗与门极电阻关系

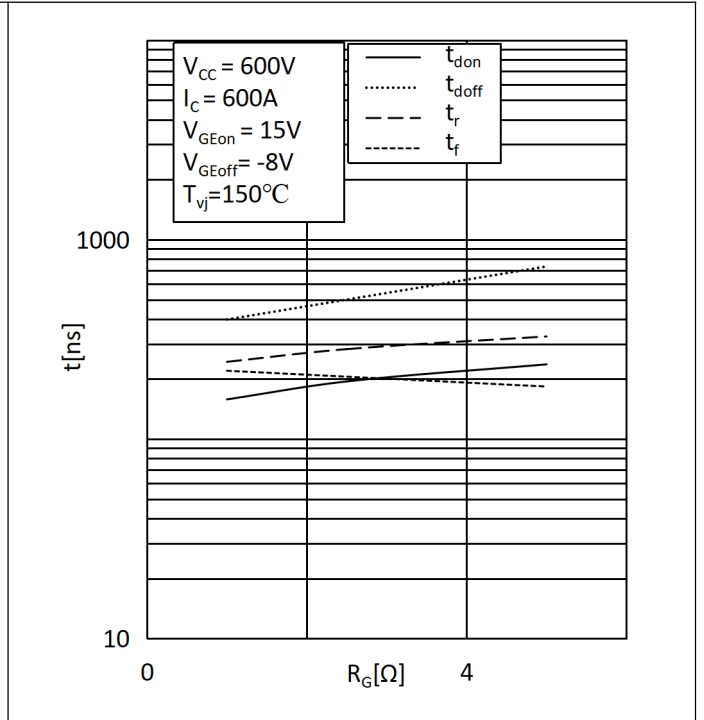

Fig.6: Switching Times vs. Gate Resistor

图 6: 开关时间与门极电阻关系

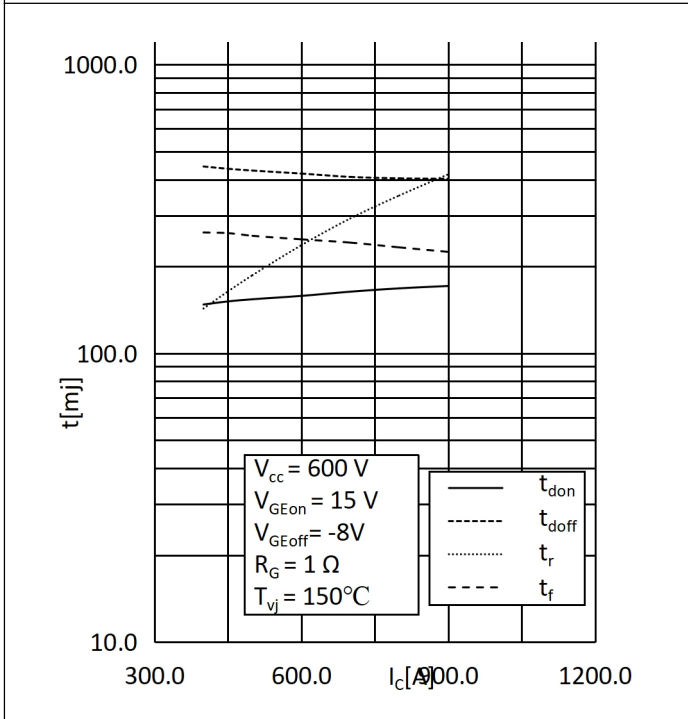

Fig.7: Switching Times vs. I_c

图 7: 开关时间与集电极电流关系

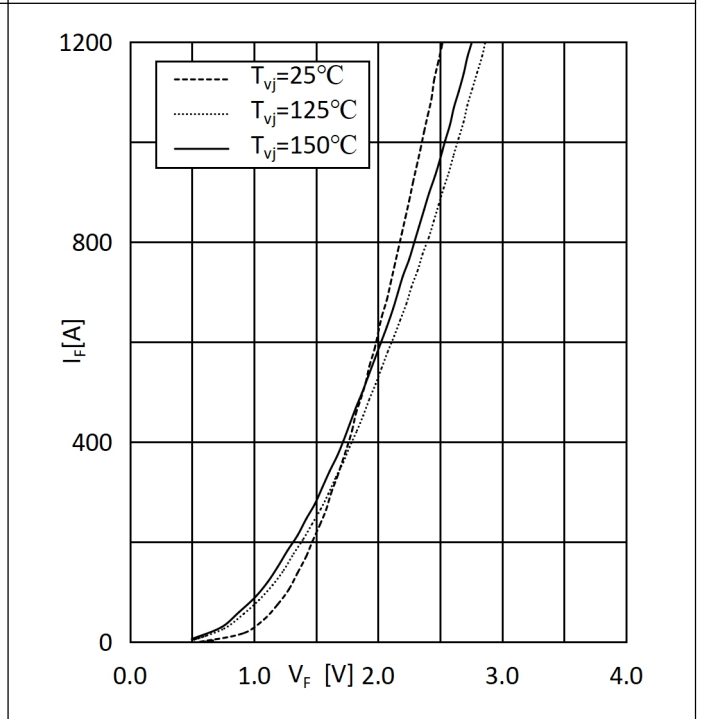

Fig.8: Forward characteristic-Chopper

图 8: 正向特性-斩波

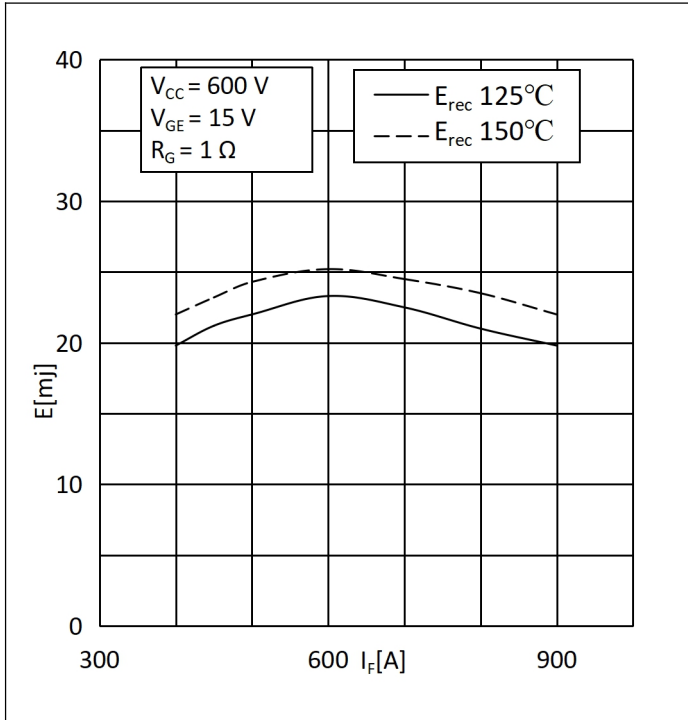

Fig.9: Reverse recovery Energy-Chopper
图 9: 反向恢复损耗-斩波

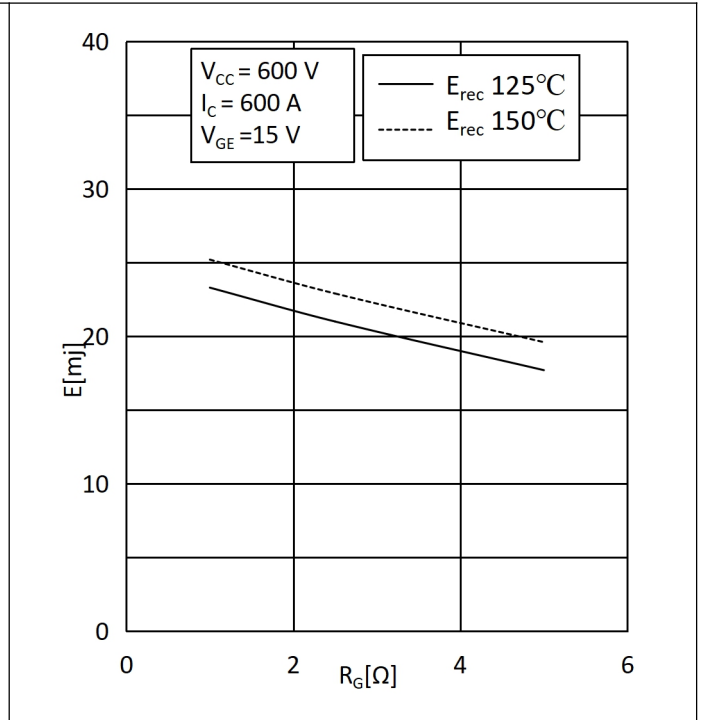

Fig.10: Reverse recovery Energy vs. Gate Resistor-Chopper
图 10: 反向恢复损耗与门极电阻关系-斩波

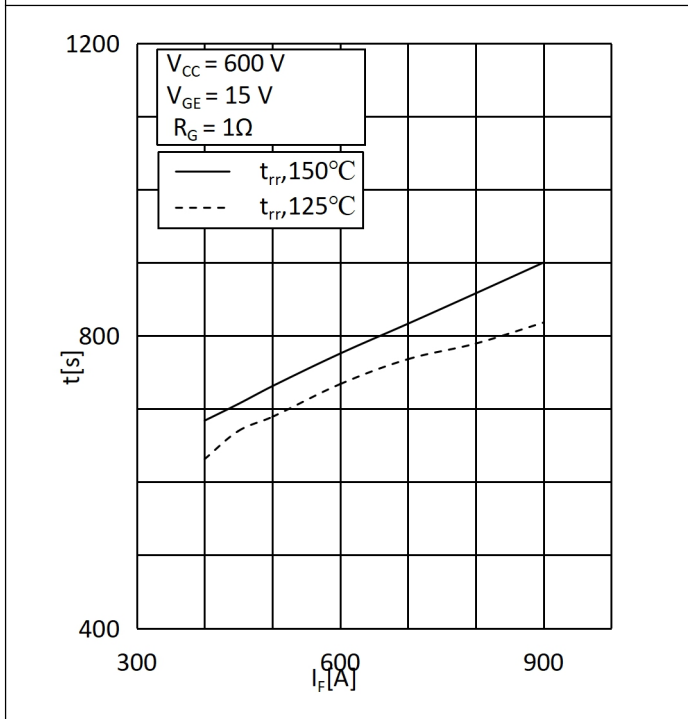

Fig.11: Reverse Recovery Times vs. I_F -Chopper
图 11: 反向恢复时间与正向电流关系-斩波

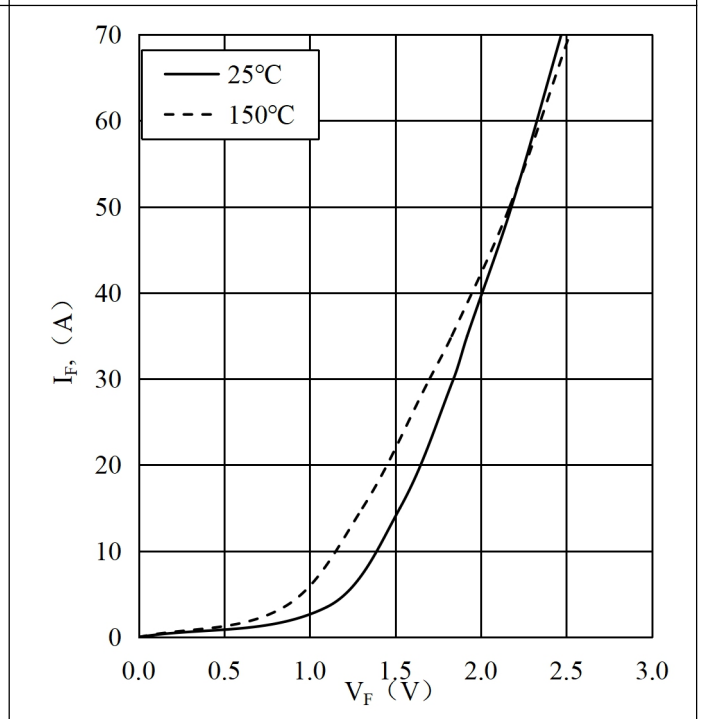

Fig.12 Typ. Forward Characteristics of Diode-Reverse
图 12 二极管正向偏压特性-反向恢复

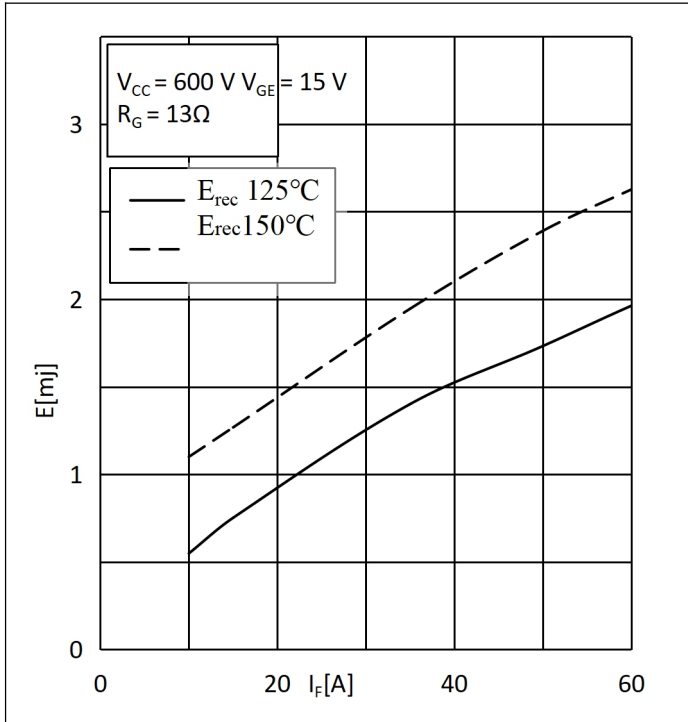

Fig.9: Reverse recovery Energy-Reverse
图 9: 反向恢复损耗-反向恢复

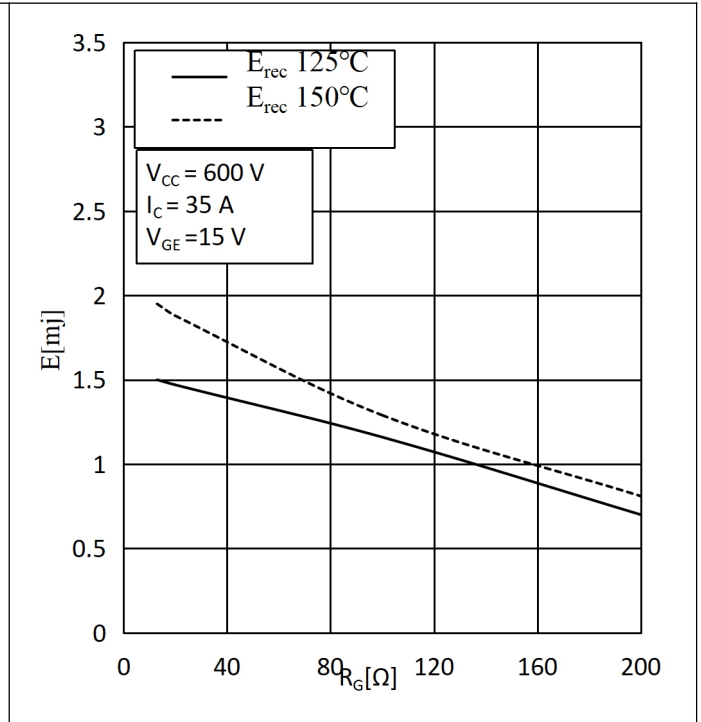

Fig.10: Reverse recovery Energy vs. Gate Resistor-Reverse
图 10: 反向恢复损耗与门极电阻关系-反向恢复

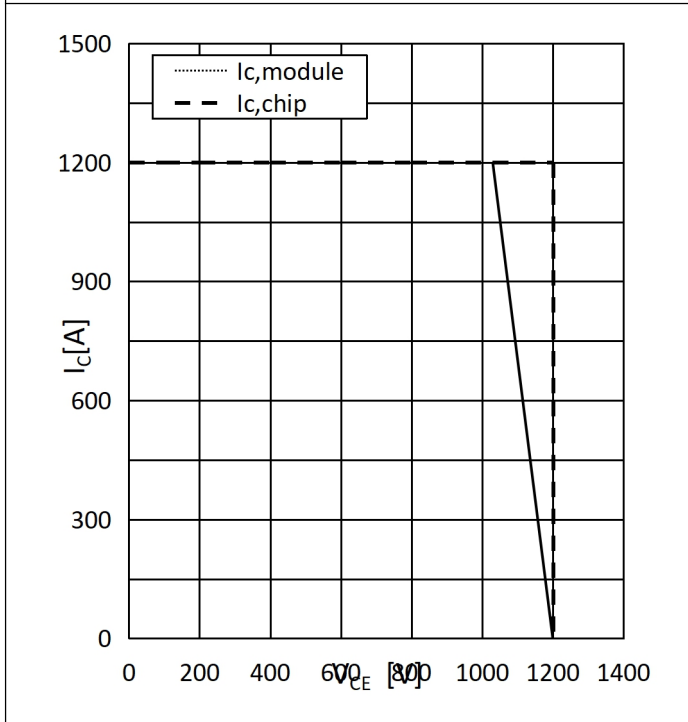

Fig.12: Reverse Bias Safe Operating Area
图 12: 反偏安全工作区

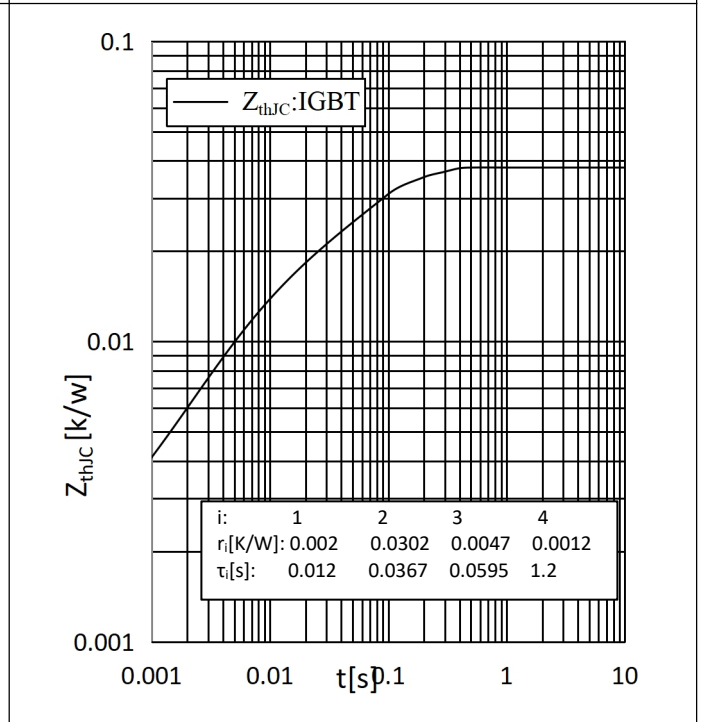

Fig.13: Typ. transient thermal impedance(IGBT) Z_{thJC} IGBT(K/W)
图 13: 典型的瞬态热阻抗(IGBT) Z_{thJC} IGBT(K/W)

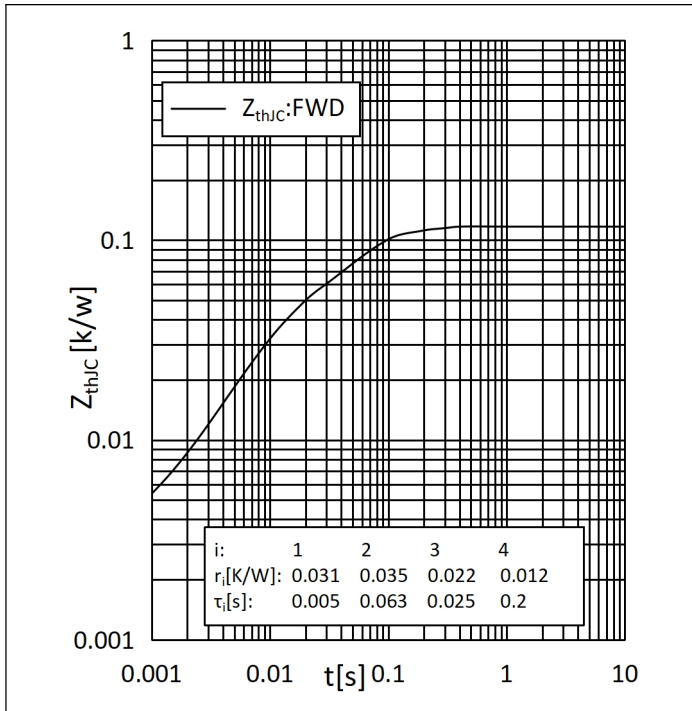

Fig.14: Typ. transient thermal impedance(FWD) Z_{thJC} FWD(K/W)

图 14: 典型的瞬态热阻抗(FWD) Z_{thJC} FWD(K/W)

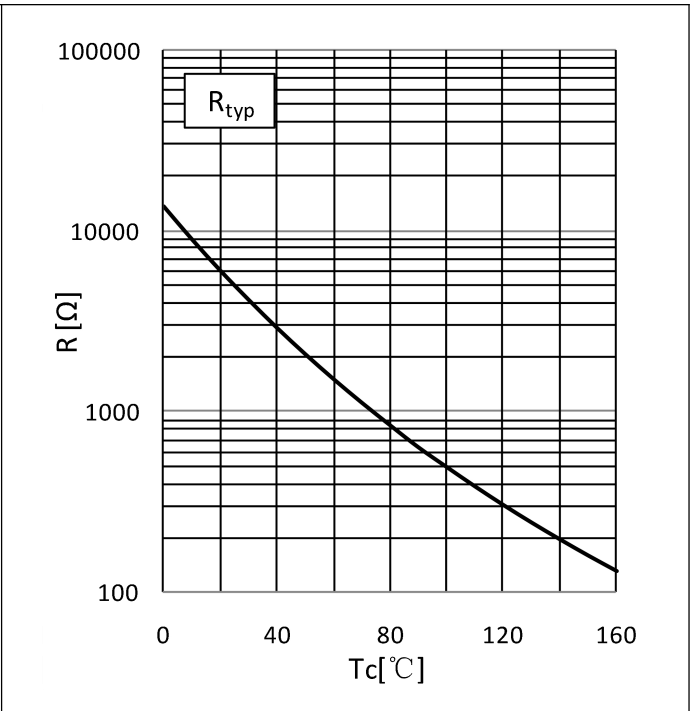
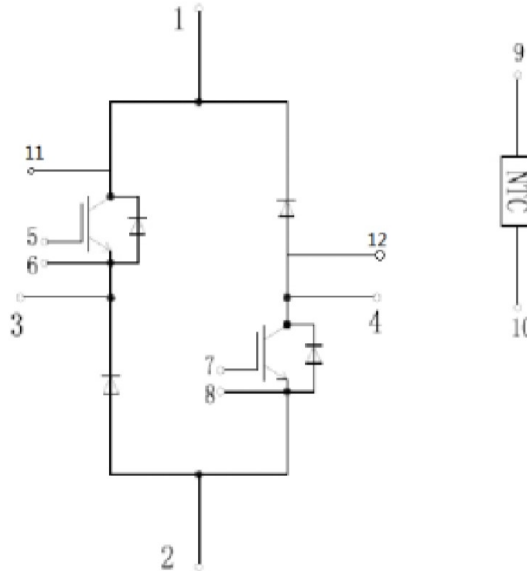

Fig.15:Typ. NTC-Temperature Characteristics

图 15: 典型的 NTC 电阻-温度特性

Circuit Diagram/接线图



Package outlines/封装尺寸

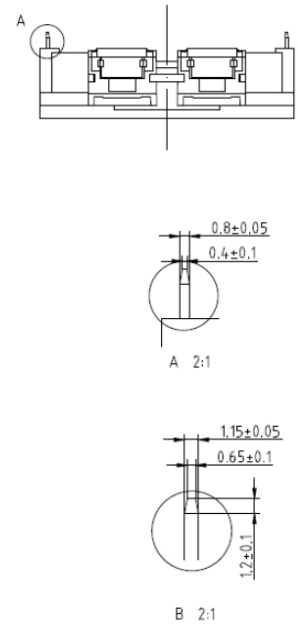
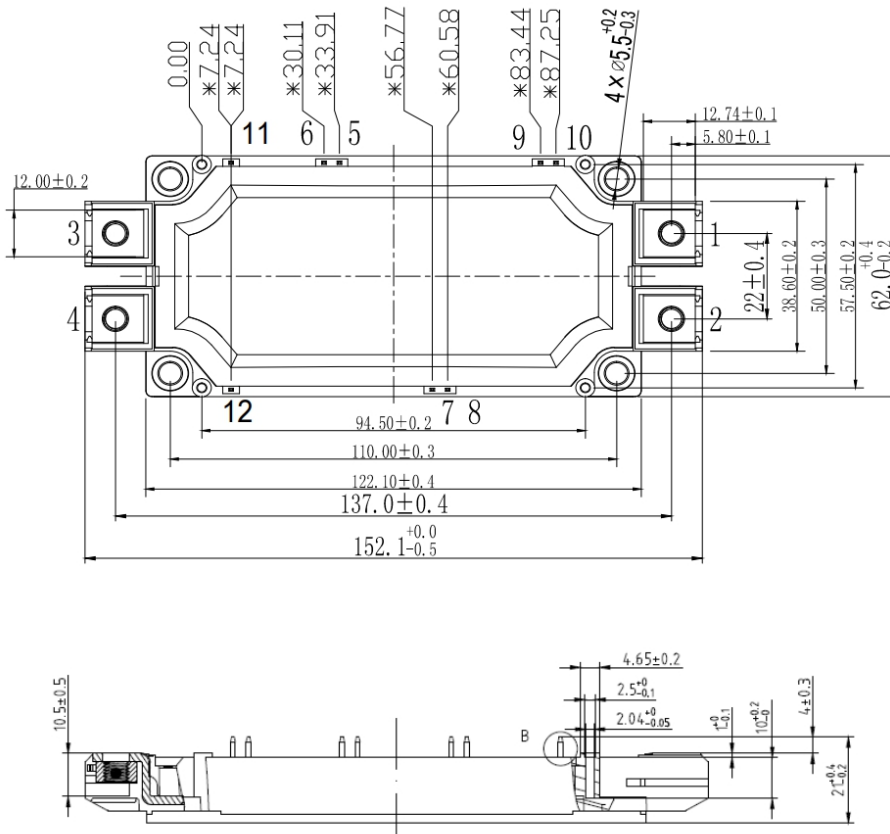

Attention

1. When installing the module, please wear an electrostatic bracelet to prevent the gate breakdown and the imbalance power may damage the internal chip, even to damage the module.

当您安装模块时,请佩戴静电手环防止栅极被击穿,静电可能会破坏芯片,甚至损坏模块。

2. This is an electrostatic sensitive device, please observe the international standard IEC 60747-1, chap. IX.

这是静电敏感器件,请遵循国际标准 IEC 60747-1, chap. IX。

Restrictions on Product Use

- The information contained herein is subject to change without notice.

此处包含的信息如有变更,不另通知。

- BYD Semiconductor Co., Ltd. exerts the greatest possible effort to ensure high quality and reliability. Nevertheless, semiconductor devices in general can malfunction or fail due to their inherent electrical sensitivity and vulnerability to physical stress. It is the responsibility of the buyer, when utilizing BYD products to comply with the standards of safety in making a safe design for the entire system, including redundancy, fire-prevention measures, and malfunction prevention, to prevent any accidents, fires, or community damage that may ensue. In developing your designs, please ensure that BYD products are used within specified operating ranges as set forth in the most recent BYD products specifications.

比亚迪半导体有限公司致力于产品的高性能和高可靠性。然而,因为半导体器件固有的电敏感和较弱的抗物理压力能力,模块容易因此导致失效。当用户购买 BYD 的产品时,用户有责任按照安全标准来为整个系统做出安全的设计,包括冗余度、防火、失效预防、来预防任何可能发生的事故、火灾或者可能引起的社区危害。请改善您的设计,确保 BYD 的产品在额定范围内使用并参考最新的 BYD 产品规格书。

- The BYD products listed in this document are intended for usage in general electronics applications (personal equipment, measuring equipment, industrial robotics, transportation instruments, domestic appliances, etc. These BYD products are neither intended nor warranted for usage in equipment that requires extraordinarily high quality and/or reliability or a malfunction or failure of which may cause loss of human life or bodily injury ("Unintended Usage"). Unintended Usage include atomic energy control instruments, airplane or spaceship instruments, traffic signal instruments, combustion control instruments, medical instruments, all types of safety devices, etc.. Unintended Usage of BYD products listed in this document shall be made at the customer's own risk.

目录中列出的 BYD 产品是用于通用电子装置(个人装置、测量装置、工业机器人、运输装置、家用电器等等)这些 BYD 的产品既不是用于超高质量要求,也不是用于失效后会危害人身安全的场合。比如原子能控制装置、飞机或航空器装置、交通信号装置、燃烧控制装置、医疗装置、所有类型的安全设备等等,用在这些不合适的场合会导致用户自己的风险。