



PRODUCT SPECIFICATION

Model No: BOF-2016WY-DMC

For reference only.

Subject to change maybe necessary in a limited number of cases

Descriptions:	
•	Ceramic Substrate Type
•	SMD Chip Type
•	Emitting Color : Yellow
•	Viewing Angle : 130°

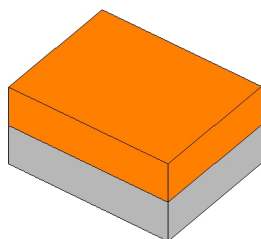

LED 胶体为软硅胶封装，请避免外力碰撞。

CUSTOMER APPROVED SIGNATURES	APPROVED BY	CHECKED BY	PREPARED BY
	Lin. yankai	Gao. yang9	Chen. yunfa

Address: Xiangshui River, Economic Development Zone, Daya Bay, Huizhou, Guangdong, 516083 P.R. China

地址: 广东省惠州市大亚湾响水河 (516083)

Tel: +86-755-89888888; +86-752-5118888

电话: +86-755-89888888; +86-752-5118888

http: // www.byd.com.cn

Applications

- Exterior Automotive Lighting

Device Selection Guide

Model No.	Chip		Epoxy Color
	Material	Emitting Color	
BOF-2016WY-DMC	InGaN	Yellow	Yellow Diffused

LED 胶体为软硅胶封装，请避免外力碰撞。

Package Outline Dimensions

Dimensions: 2.04(L) × 1.64(W) × 1.0(H) mm.

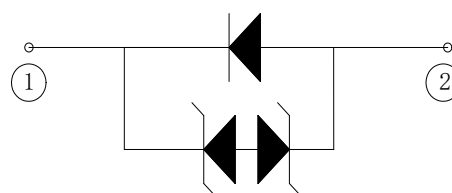
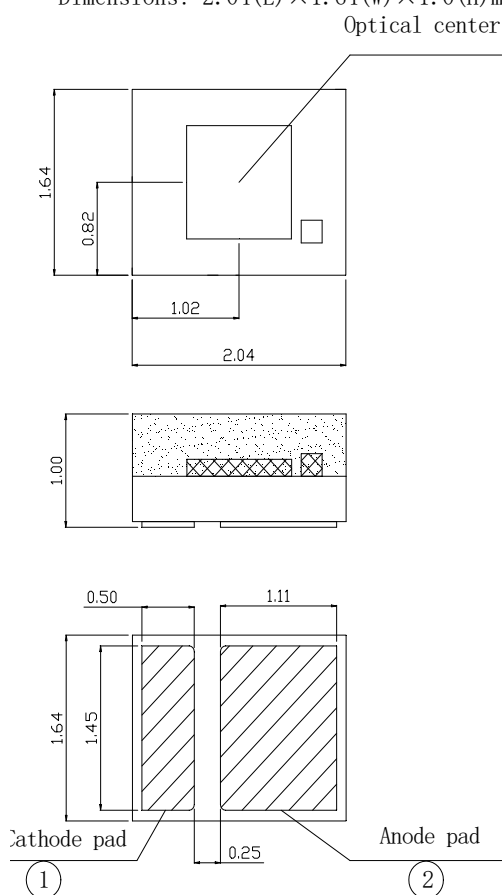

Recommended Solder pattern

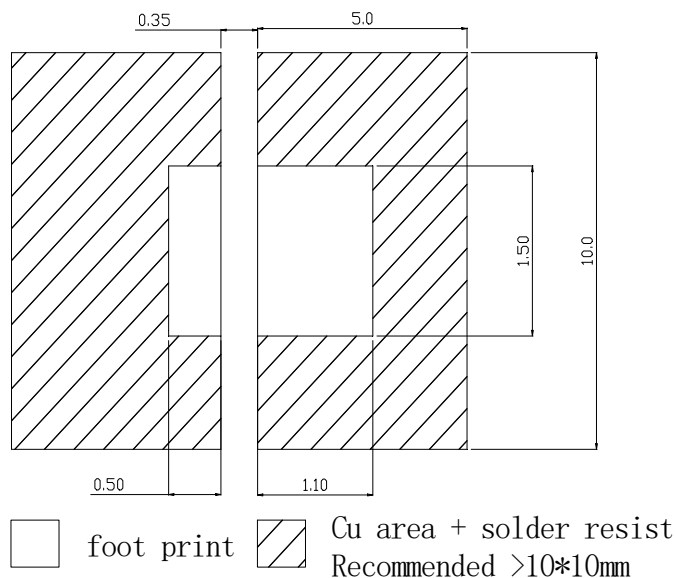

Note:

1. Dimensions are in millimeters.
2. Tolerances unless mentioned are ± 0.2 mm.



■ Absolute Maximum Ratings (Ta=25° C)

Items	Symbol	Absolute Maximum Ratings	Unit
Power Dissipation	P _d	1.0	W
Junction Temperature	T _j	150	° C
Forward Current (DC)	I _F	350	mA
Peak Forward Current* (0.35s: on, 0.35s: off)	I _{FP}	700	mA
Operation Temperature	T _{opr}	-40 ~ +105	° C
Storage Temperature	T _{stg}	-40 ~ +105	° C
Wavelength	W _p	590 ~ 610	nm
Wavelength	W _d	585 ~ 590 ~ 595	nm
50% Power Angle	2 θ _{1/2}	120 ~ 130 ~ 140	deg
Thermal resistance junction/board	R _{th}	≤10	k/w
ESD (HBM)	ESD	≥8	KV
Lead Soldering Temperature	T _{sol}	260° C for 5 Seconds	

*Pulse Width ≤200ms and Duty ≤1/10;

*For 250 mA all reliability items are tested under good thermal management with 16x 16 mm² MPCB, Ts<125°C.

■ Typical Electrical & Optical Characteristics (Ta=25° C)

Items	Symbol	Condition	Min.	Typ.	Max.	Unit
Forward Voltage	V _F	I _F =150mA	2.6	2.9	3.6	V
	V _F	I _F =350mA	2.8	3.1	3.8	V
Reverse Current	I _R	V _R = -5v	---	---	10	μ A
Chromaticity Coordinate	(x, y)	I _F =150mA	0.545/ 0.390	0.57/ 0.42	0.609/ 0.439	---
Luminous Flux	Φ _v	I _F =150mA	26	33	---	Lm
	Φ _v	I _F =350mA	40	65	---	Lm

■ Ranks Combination (IF=150mA)

Φ V /Lm	F : 26-32	G: 32-40	H: 40-50	/	/
VF/v	M: 2.8-2.9	N: 2.9-3.0	O: 3.0-3.1	P: 3.1-3.2	Q:3.2-3.3
CHC	YA	YB	/	/	/

Notes:

- *Tolerance of measurement of Luminous Flux is ±15%;
- *Tolerance of measurement of forward voltage is ± 0.15V;
- *Tolerance of measurement of Ir is ± 3uA;
- *Tolerance of measurement of If is ± 5%;
- *Chromaticity Coordinate s measurement allowance : ±0.015.

■ Chromaticity coordinate (IF=150mA)

BYD 颜色分档

YA	0.5735	0.4090
	0.5868	0.4130
	0.5680	0.4320
	0.5520	0.4230
	0.5735	0.4090
YB	0.5900	0.3980
	0.6000	0.3993
	0.5868	0.4130
	0.5735	0.4090
	0.5900	0.3980

■ CIE Graph

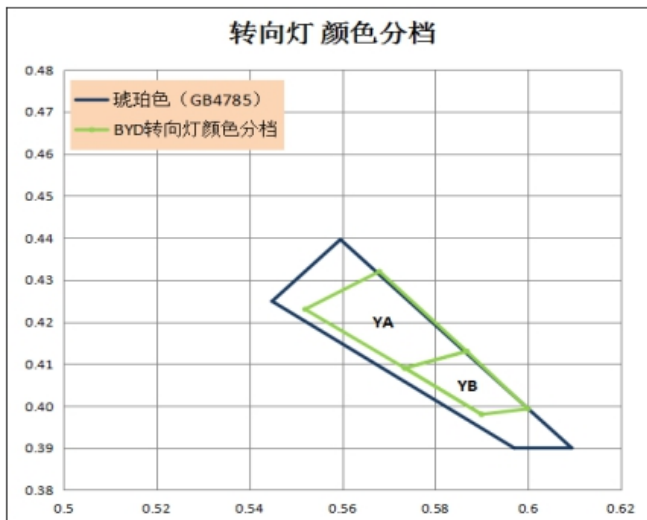
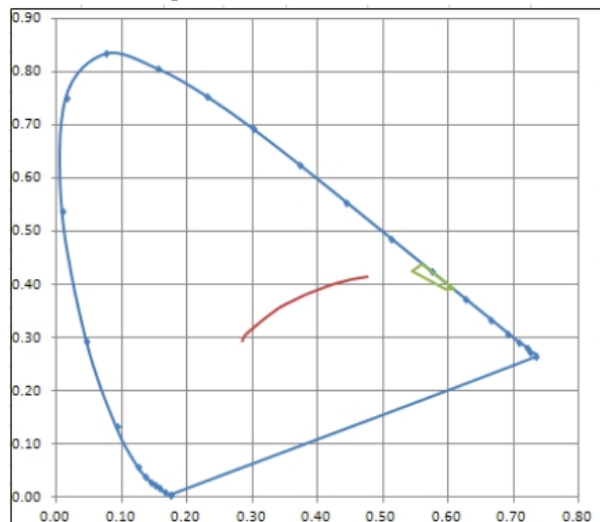

Note:

- 1、Percentage of UV: 10^{-5} W/lm acc. to GB 25991 regulation.
- 2、Acc. to white area GB 4785.



■ Reliability

1) Test Items and Results:

Classification	Test Item	Standard Test Method	Conditions	Duration	Units Tested	Number Of Damaged
Life Test	Operating Life Test *	JIS7021:B4 MIL-STD-202:107D MIL-STD-750:1026	Ta=85±5℃, IF=350mA *	1000Hrs	11	0/11
		JESD22-A101	Ta=85±5℃ RH=85±5%RH IF=350mA *	1000 Hrs	11	0/11
Environment Test	High Temperature Storage	JIS7021:B10 MIL-STD-202:210A MIL-STD-750:2031	Ta=125±5℃	1000Hrs	11	0/11
	Low Temperature Storage	JIS7021:B12	Ta= -40±5℃	1000Hrs	11	0/11
	Temp. & Humidity Test	JIS7021:B11 MIL-STD-202:103D	Ta=85±5℃ RH=85±5%RH	1000Hrs	11	0/11
	Thermal Shock Test	JIS7021B4 MIL-STD-202:107D MIL-STD-750:1026	-40℃ ← - → 125℃ 15min 10sec 15min	1000 Cycles	11	0/11
	ESD	JEDEC JS-001: HMB	8Kv	10 Cycles	11	0/11
Soldering Test	Resistance to soldering	-	Tsol=260±5℃, 10sec	3 time	22	0/22

*Reliability items are tested under good thermal management 16x16 mm² MPCB, Ts<125℃。

2) Criteria for Judge The Damage:

Items	Symbol	Condition	Criteria for Judge	
			Min.	Max.
Forward Voltage	V _F	I _F =150mA	---	initial value x 1.2
Reverse Current	I _R	V _R =5V	---	not designed for reverse operation
Luminous Flux (Lm)	Φ _v	I _F =150mA	initial value x 0.80	---



■ Typical Electrical / Optical Characteristics Curves
($T_a = 25^\circ\text{C}$ Unless Otherwise Noted)

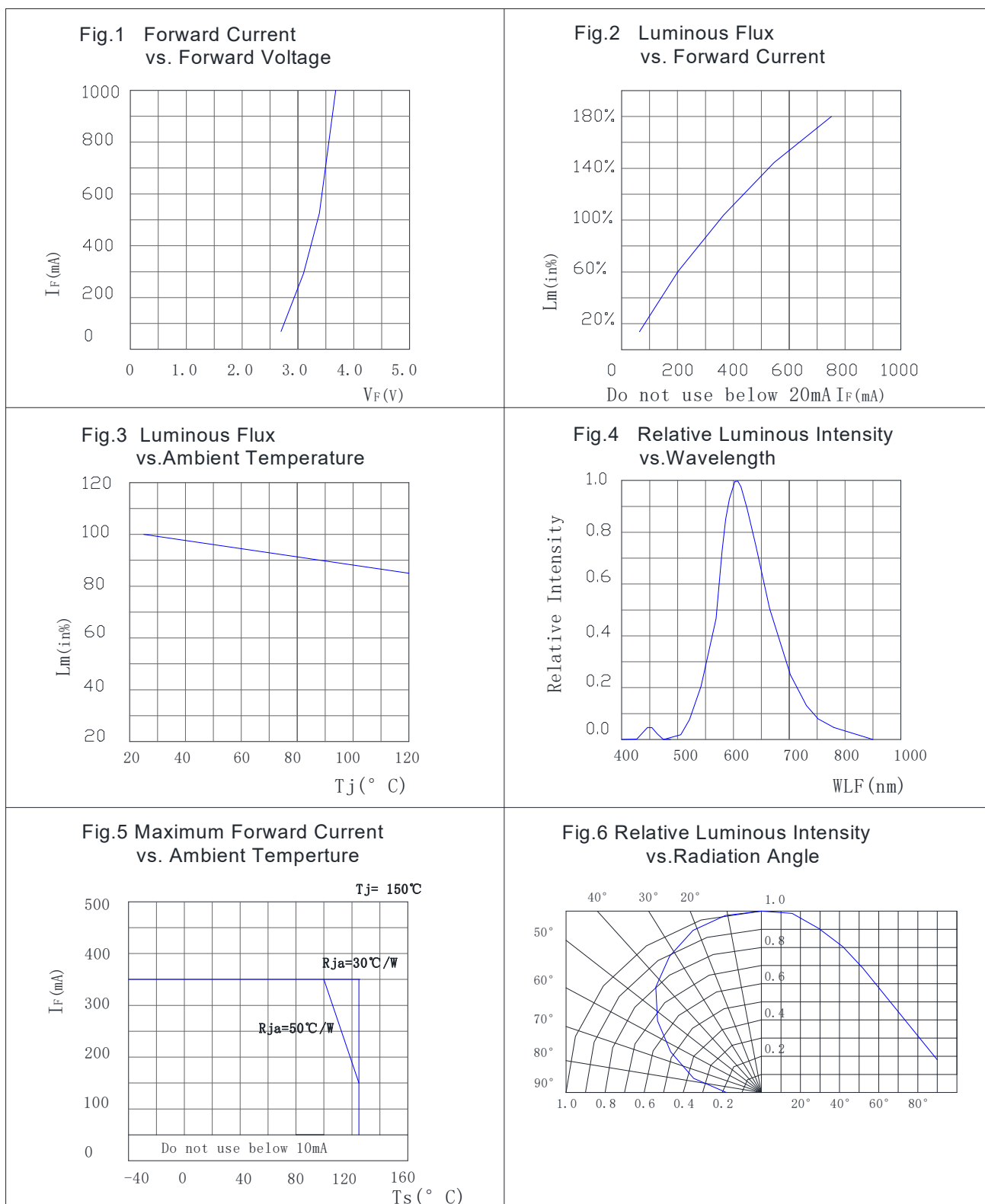



■ Reel Specification:

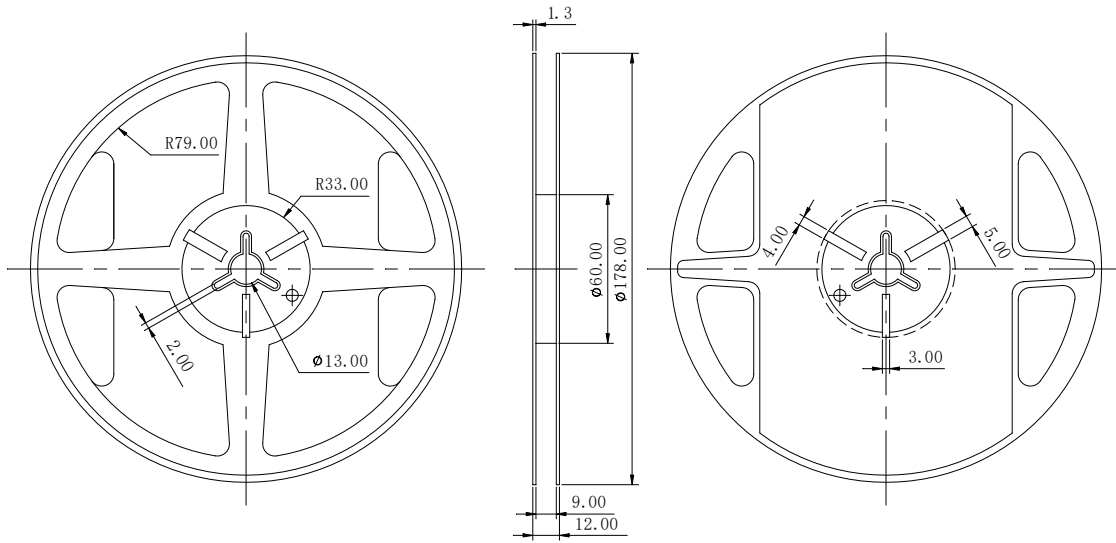

■ Taping Specification - (500, or1000, or 2000pcs / reel)

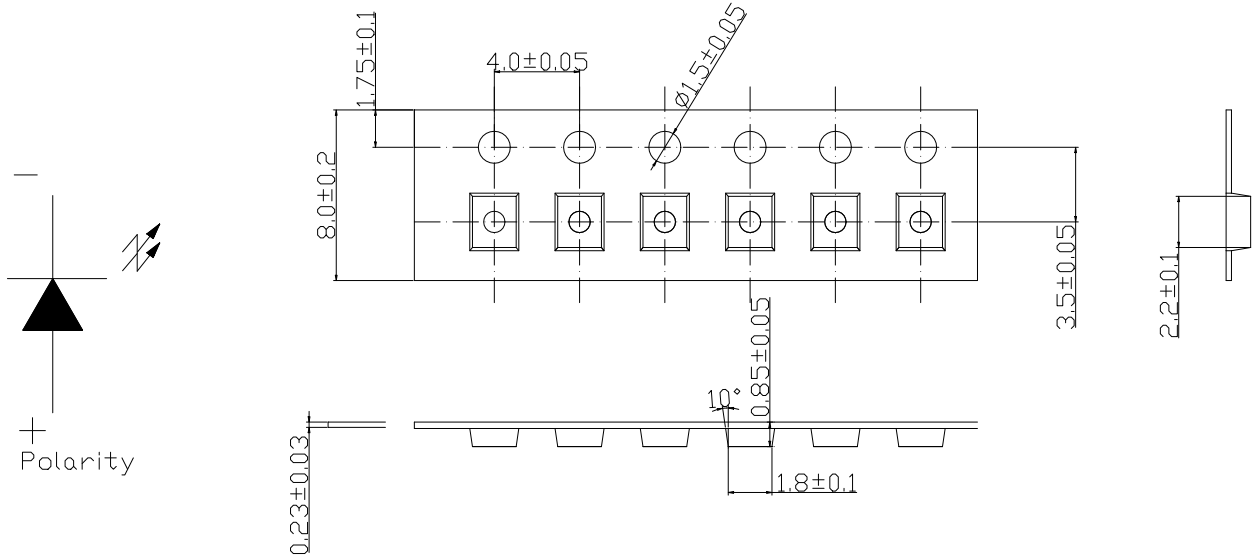



■ Packing Type

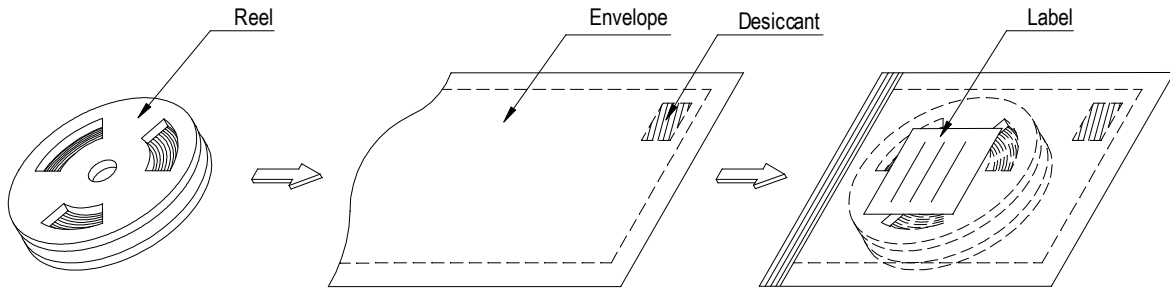

■ Precautions For Use

1. Over - current - proof

Customer must apply resistors for protection, otherwise slight voltage shift will cause big current change (Burn out will happen).

2. Storage

- 2.1 Do not open moisture proof bag before the products are ready to use;
- 2.2 The LEDs should be kept at 30°C or less and 70%RH or less, and the storage life limits are 3 months;
- 2.3 Product complies to MSL Level 2 acc. to JEDEC J-STD-020E.

3. Soldering

3.1 Reflow Soldering / Time

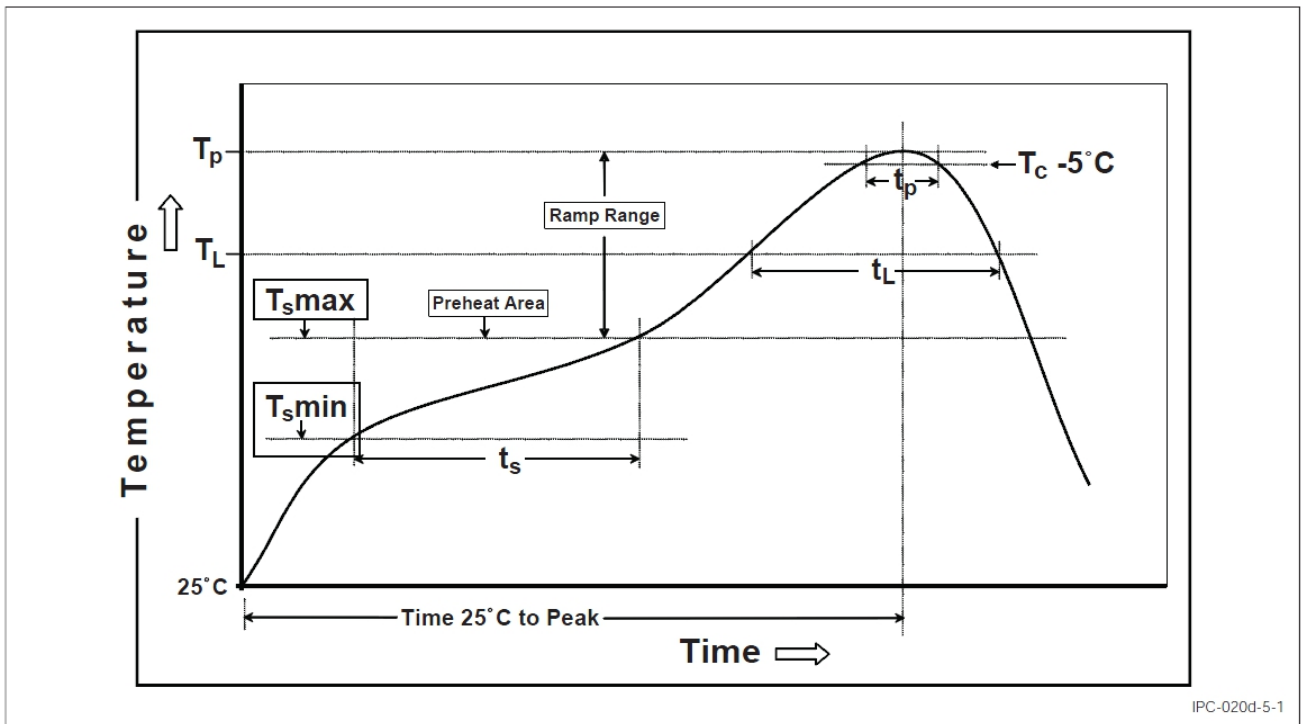



BOF-2016WY-DMC

Profile Feature	Sn-Pb Eutectic Assembly	Pb-Free Assembly
Preheat & Soak Temperature Min (T _{min}) Temperature Max (T _{max}) Time (T _{min} to T _{max}) (ts)	100° C 150° C 60-120 seconds	150° C 200° C 60-120 seconds
Average ramp-up rate (T _{max} to T _p)	3° C/second max.	3° C/second max.
Liquidous Temperature (TL) Time at Liquidous (tL)	183° C/60-150 seconds	217° C/60-150 seconds
Peak Package Body Temperature (T _p)*	235° C max.	260° C max.
Time (t _p)** within 5° C of the specified classification Temperature (T _c)	10 seconds max	10 seconds max
Average ramp-down Rate (T _p to T _{max})	6° C/second max.	6° C/second max.
Time 25° C to Peak Temperature	6 minutes max.	8 minutes max.

3.2 Reflow soldering should not be done more than two times;

3.3 While soldering, do not put stress on the LEDs during heating;

3.4 After soldering, do not warp the circuit board.

4. Caution in ESD

4.1 Electrostatic discharge (ESD) and surge current (EOS) can damage LEDs;

4.2 An ESD wrist strap, ESD shoe strap or antistatic gloves must be worn whenever handling LEDs;

4.3 All devices equipment and machinery must be properly grounded.

5. Other

5.1 Above specification may be changed without notice. BYD will reserve authority on material change for above specification;

5.2 When using this product, please observe the absolute maximum ratings and the instructions for using outlined in these specification. BYD assumes no responsibility for any damage resulting from use of the product which does not comply with the absolute maximum ratings and the instructions included in these specification.

RESTRICTIONS ON PRODUCT USE

- The information contained herein is subject to change without notice.
- **BYD Semiconductor Company Limited** exerts the greatest possible effort to ensure high quality and reliability. Nevertheless, semiconductor devices in general can malfunction or fail due to their inherent electrical sensitivity and vulnerability to physical stress. It is the responsibility of the buyer, when utilizing products, to comply with the standards of safety in making a safe design for the entire system, including redundancy, fire-prevention measures, and malfunction prevention, to prevent any accidents, fires, or community damage that may ensue. In developing your designs, please ensure that products are used within specified operating ranges as set forth in the most recent products specifications.
- The products listed in this document are intended for usage in general electronics applications (computer, personal equipment, office equipment, measuring equipment, industrial robotics, domestic appliances, etc.). These products are neither intended nor warranted for usage in equipment that requires extraordinarily high quality and/or reliability or a malfunction or failure of which may cause loss of human life or bodily injury (“Unintended Usage”). Unintended Usage include atomic energy control instruments, airplane or spaceship instruments, transportation instruments, traffic signal instruments, combustion control instruments, medical instruments, all types of safety devices, etc.. Unintended Usage of products listed in this document shall be made at the customer’s own risk.